

9001 Series

DIN41612 R Type Male

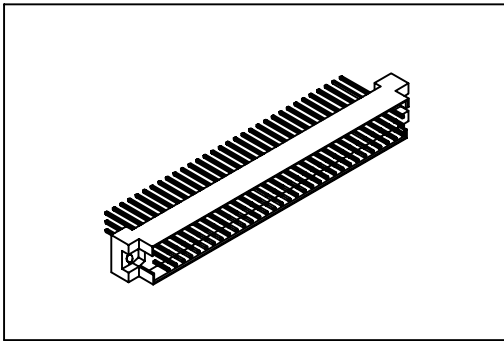

Material:

Housing: 30% Glass filled PBT UL94V-0.

Contacts: Brass.

Electrical Characteristics:

Current Rating: 2 AMP.

Dielectric Withstanding Voltage: AC 1000V For 1 minute.

Insulator Resistance: 1000MΩmin. at DC 500V.

Contact Resistance: 30mΩmax. at DC 100mA.

Operating Temperature: -55°C ~ +105°C.

Features:

- * UL, cUL listing.
- * Mates with Female 3Row
9001-1296, 1264, C Type.
9001-1496, 1464, R Type.
9001-1264, IDC Type.

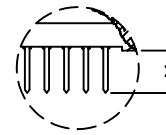
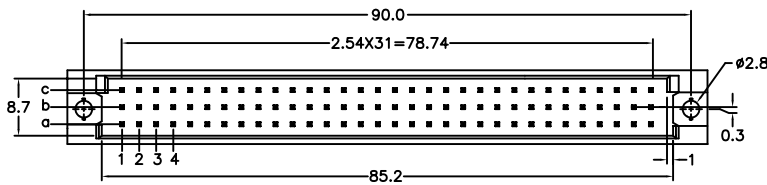

Dip Type

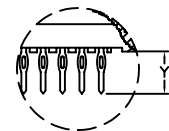

Press Fit Type

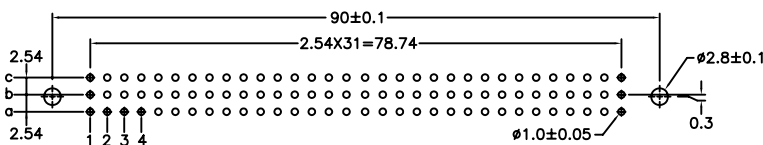
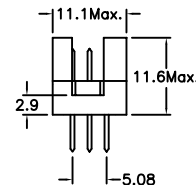
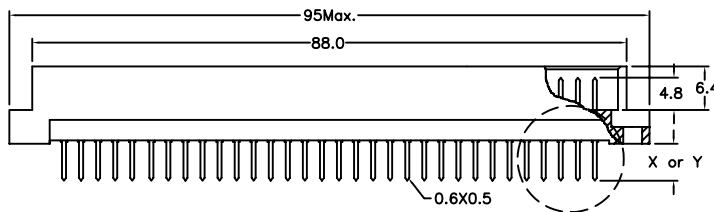

P.C. Board Layout

Length	1	2	W1	W2
X	4.0	2.5	13	17
Y	4.6	6.3	13	17
Pitch	Position	Rows with Contacts	Contact Arrange	
2.54mm	96	a b c		
	64	a - c		
	32	a - -		
5.08mm	48	a b c		
	32	a - c		
	16	a - -		

Ordering information

9001-1 3 96 1 C 00 P L1 A
 Series 1: 2.54mm 3: Male Position 1: Dip Length C: Dip Tin 00: G/F Blank: Dip Blank: W/O A: Tray
 2: 5.08mm Contact Gold 10: 10μ" P: Press Fit Lock Package
 W1: Dip Length G: Gold 15: 15μ" L1: With Lock
 W2: Dip Length 30: 30μ" See Page CA04

*Standard Gold Flash.