

SPECIFICATION

Product : Topview 3528 SMD LED

Part No. : IWS-351-UY-O

Customer :

Date : 2007. 03. 19 Ver. 1.0

Customer :

Checked By	Checked By	Checked By	Checked By	Approval

Manufacturer : ITSWELL Co., LTD

Proposed By	Checked By	Checked By	Checked By	Approval
				

Comment



Suwon Company :

442-190, 802 Uman Industrial Complex, 300-5 Uman-dong, Paldal-gu, Gyeonggi-do, Korea
Tel:+82-31-244-0002, FAX:+82+31-244-1806

Ochang Company :

363-880, 9-4Block, Ochang Scientific Industrial Complex, Ochang, Cheongwon, Chungbuk, Korea
URL : www.itswell.com, TEL : int) 82-43-218-1800, FAX.: int) 82-43-218-1805

Topview 3528 SMD LED IWS-351-UY-O



1. Features

- 1chip High-Luminosity Chip LED
- 3.5 mm x 2.8 mm x 1.8 mm (L x W x H) small size surface mount type
- Wide Viewing angle
- Long operating life (up to 70,000 hours)

2. Applications

- Automotive: Backlight in dashboard and switch
- Lighting device: Indicator, lighting
- Camera flash, Hand Carrier Flash
- General use

3. Outline Drawing and Dimension

Unit : mm
Tolerance : ± 0.1

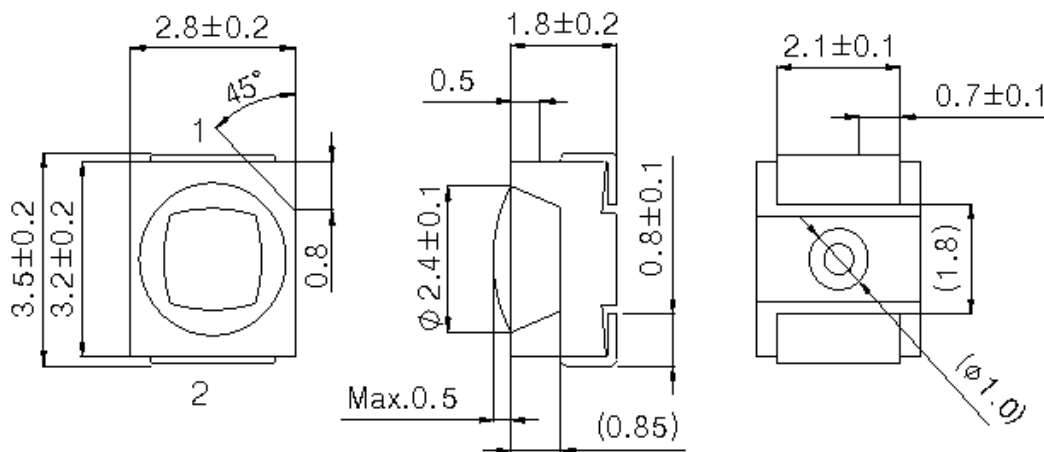

BLOCK DIAGRAM



Note

1. All dimensions are in millimeters
2. All dimensions without tolerances are for reference only

4. Absolute Maximum Ratings(Ta = 25 °C)

Parameter	Symbol	Value	Unit
Power Dissipation per chip	P_d	78	mW
Continuous Forward Current per chip	I_F	30	mA
Peak Forward Current ^{□1}	I_{FP}	100	mA
Reverse Current	I_R	5	μA
Operating Temperature	T_{opr}	-30 ~ 85	°C
Storage Temperature	T_{stg}	-40 ~100	°C
Soldering Temperature	T_{sol}	260 (5sec)	°C

□1 Duty ratio = 1/10, Pulse width = 0.1ms

5. Electro-optical Characteristics(Ta = 25 °C)

Parameter	Symbol	Conditions	Min.	Typ.	Max.	Unit.
Forward Voltage ²	V_F	$I_F = 20 \text{ mA}$	-	2.2	2.6	V
Reverse Current	I_R	$V_R = 5 \text{ V}$	-	-	10	μA
Dominant Wavelength ³	W_d	$I_F = 20 \text{ mA}$	588	-	595	nm
Luminous Intensity ^{□4}	I_v	$I_F = 20 \text{ mA}$	500	-	1100	mcd
View angle	$2\theta_{1/2}$	$I_F = 20 \text{ mA}$	-	120	-	deg

² Forward Voltage has an accuracy of $\pm 0.1\text{V}$

³ Dominant wavelength has an accuracy of $\pm 1\text{nm}$

⁴ Luminous Intensity is tested by a tester calibrated by CAS 140B(CIE LED_B) and has an accuracy of 10%

6. Typical Characteristics Curves

Forward Current vs. Forward Voltage

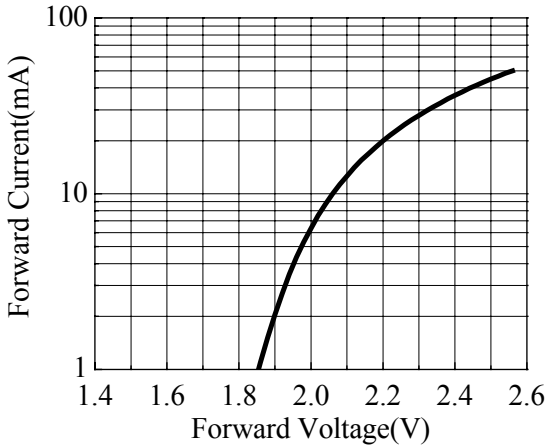

Forward Current vs. Ambient Temperature

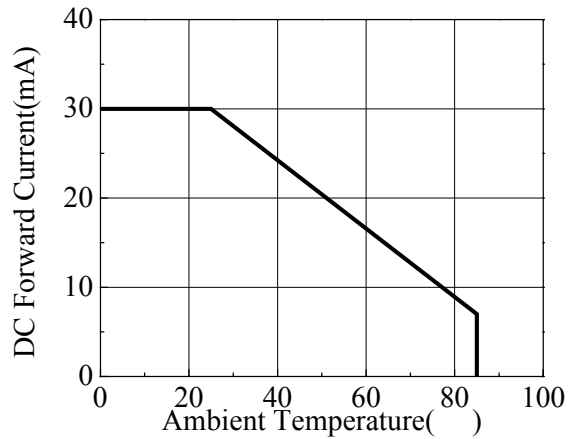

Relative Luminous Intensity vs. Ambient Temperature

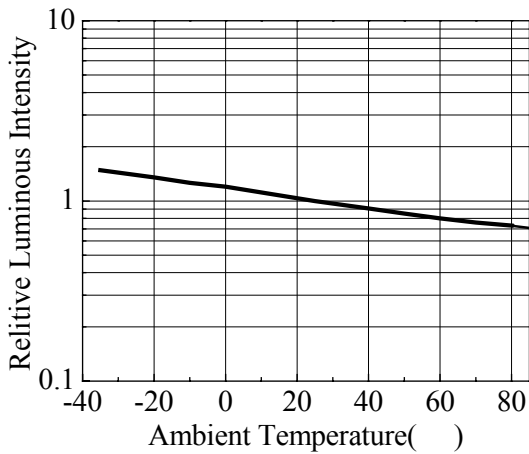

Relative Luminous Intensity vs. Forward Current

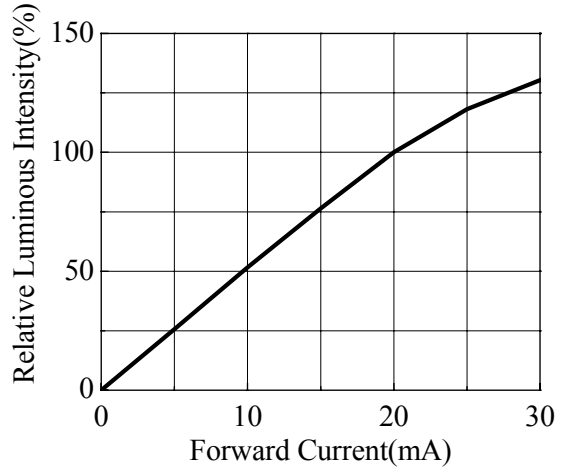

Relative Intensity vs. Wavelength

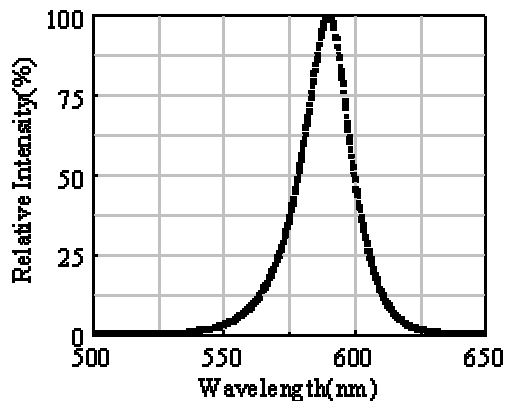

Radiation Diagram

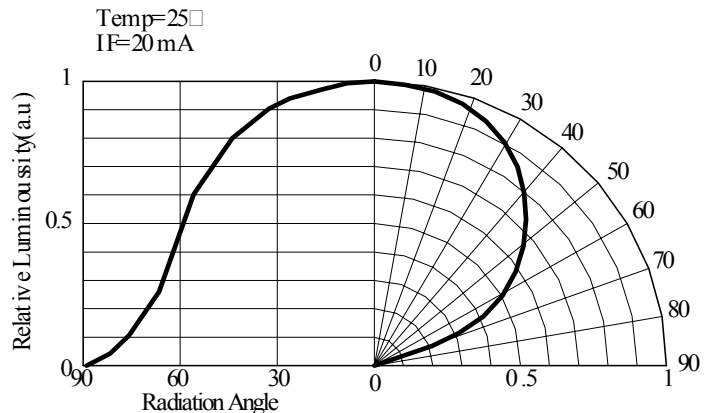

Topview 3528 SMD LED IWS-351-UY-O



7. Dimension of Tape / Reel

7.1 Tape Dimension

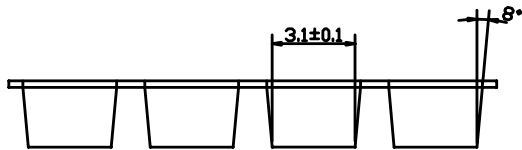
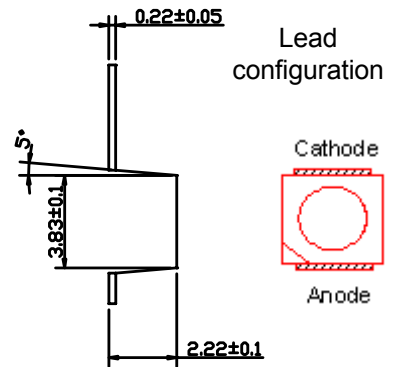
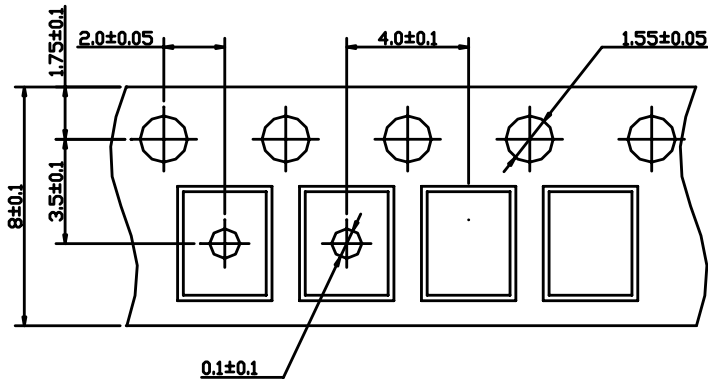

7.2 Reel Dimension

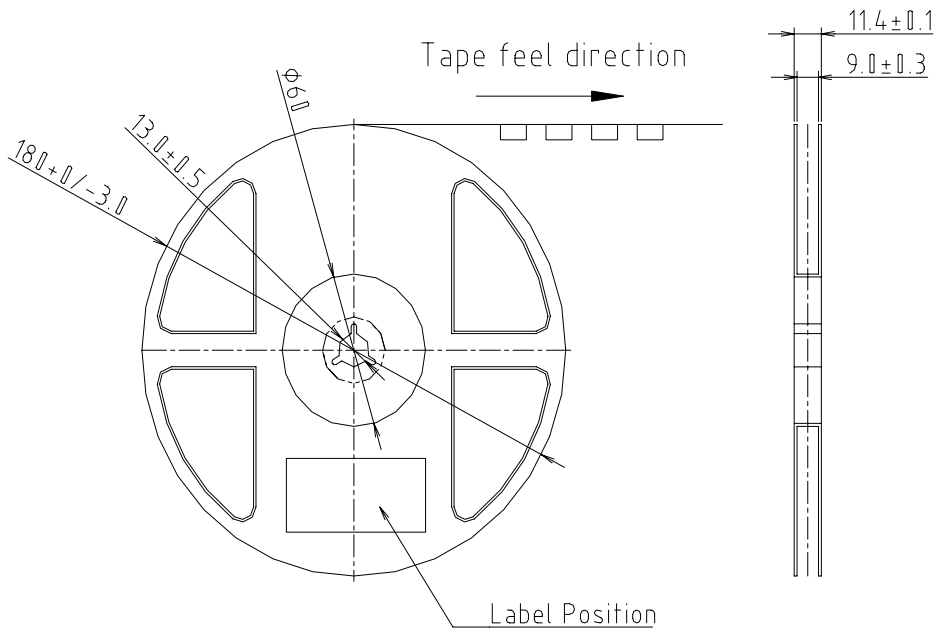

Topview 3528 SMD LED IWS-351-UY-O



8. Packing Dimension

Unit :mm

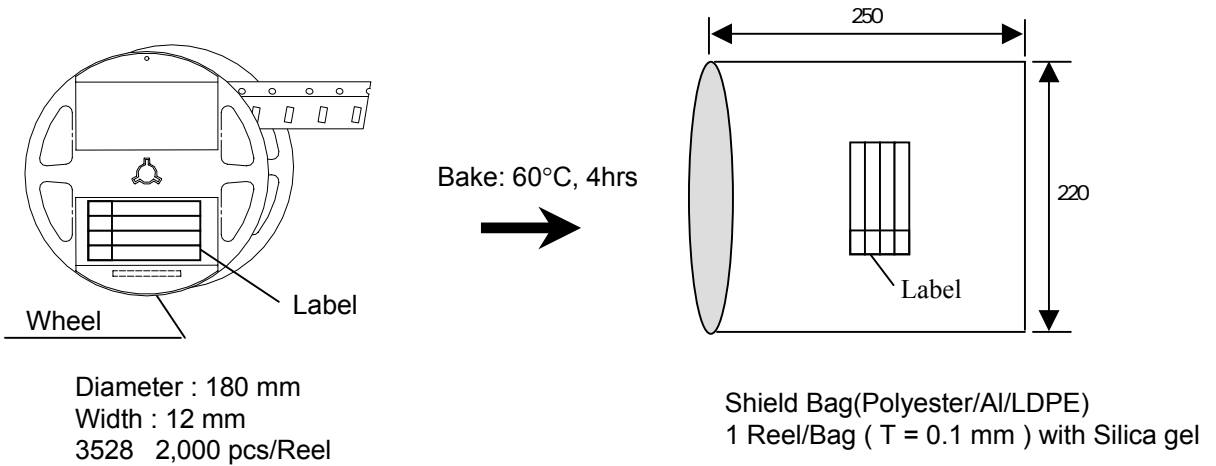

Al Pack & Reel Label, Box Label

(70 × 37)

		RANK #		
Lot :		MS-351-UY-O		
	MN	AG	MAX	SID
Vf[volt]				
M[mcd]				
WD[m]				
Qty :		yyy/mm/dd		

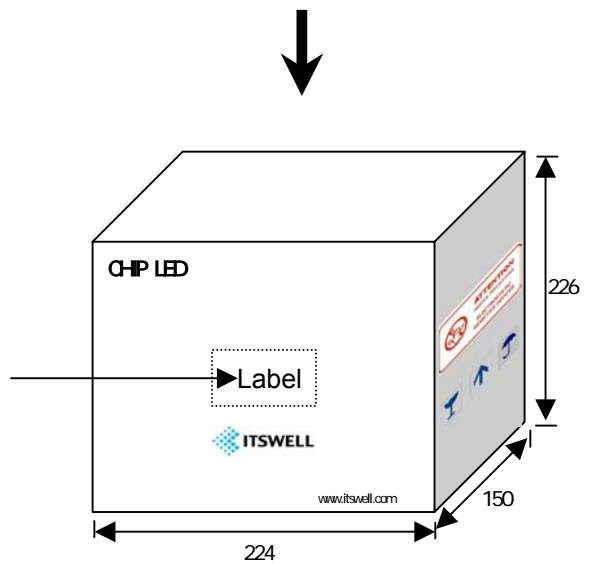

Maximum 10 Bags / 1Inner Box
3528 20,000 pcs / 1 Inner Box

9. Precaution in use

9.1 Soldering Conditions

- When soldering Power SMD, Heat may affect the electrical and optical characteristics of the LEDs.
- In soldering, do not stress the lead frame and the resin part under the high temperature.
- The silicone part should be protected from mechanical stress or vibration until the Power SMD return to room temperature after soldering.
- Preliminary heating to be at 150°C max. for 180 Seconds max.
- Soldering heat to be at 260°C max. for 5 sec. Max.
- For manual Soldering is Not more than 3 sec @MAX 350°C, under soldering iron

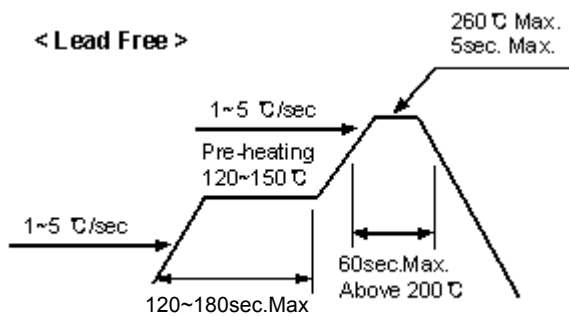

<Recommendable soldering pattern>

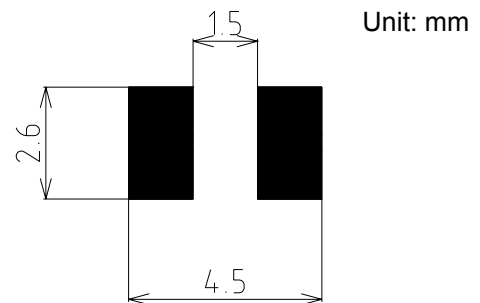

9.2 Storage

- Use with 7days after opening packing. Store in 10 to 30°C Power SMD lead frames are plated silver. The silver surface may be affected by environment which contain corrosive gases and so on. Please avoid condition which may cause the Power SMD to corroded, tarnish or discolor.

9.3 Static Electricity

- Static electricity or surge voltage damages the Power SMD . It is recommended that a wrist band or an anti-electrostatic glove be used when handling the LEDs.
- A tip soldering iron is requested to be grounded. An ionizer should also be installed where risk of static.
- All devices, equipment and machinery must be properly grounded (via 1MΩ). It is recommended that measures be taken against surge voltage to the equipment that mounts the Power SMD.

9.4 Cleaning

- Isopropyl Alcohol or Ethylene Alcohol is recommended in 5 minutes at room temperature. Don't use unspecified chemical may cause crack or haze on the surface of the epoxy resin.
- Before cleaning, a pre-test should be done to confirm whether any damage to the LED will occur.
- Freon solvents should not be used to clean the LEDs because of worldwide regulations.

10. Reliability

10.1 Reliability Test Item

Test Items	Test Conditions	Notes
High Temperature Storage	100 , 500 hr.	0/32
Low Temperature Storage	-40 , 500 hr.	0/32
Temp. Humidity Storage	60 , 90 % RH, 500 hr.	0/32
Steady State Operating life	25 , 30 mA/chip , 500 hr.	0/32
High Temperature Operating Life	85 , 5 mA, 500 hr	0/32
Low Temperature Operating Life	-30 , 30 mA, 300 hr.	0/32
Steady State Operating life Of High Humidity Heat	60 , 90 % RH, 10 mA, 300 hr.	0/32
Temperature Cycle	-40 (30min) → 80 (30min.) , 100 cycle	0/22
ESD	HBM, 100 pF, 1.5 kohm, 3 times	0/22

10.2 Criteria for Judging the Damage

Items	Test Conditions	Criteria for judgment
Luminous Intensity (IV)	IF = 20 mA	> 50% of S
Forward Voltage (VF)	IF = 20 mA	Less than 120% of U
Reverse Current (IR)	VR = 5 V	Less than 10

* U means the upper limit of specified characteristics, S means initial value.

11. Part Name Description

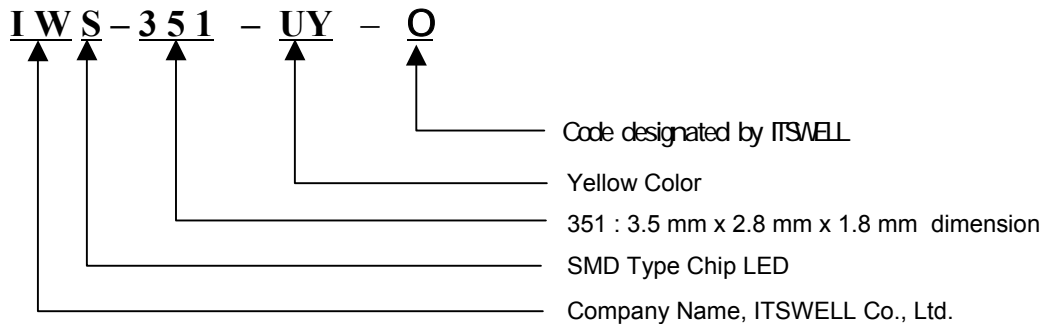

12. Rank Description

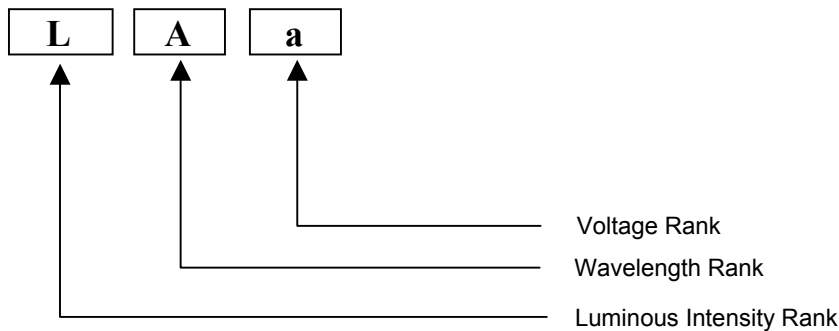

13. Attention : Electric Static Discharge (ESD) Protection



The symbol shown on the page herein to introduce 'Electro-Optical Characteristics'. ESD protection for GaP and AlGaAs based chips is still Necessary even though they are safe in low static-electric discharge. Material in AlInGaP, GaP, or/and InGaN based chips are STATIC SENSITIVE devices. ESD protection has to be considered and taken in the initial design stage. If manual work/process is needed, please ensure the device is well protected from ESD during all the process. LED's ESD Level is 'Class II' and The range of Forward Voltage is 2000V ~ 3999V.

After opening the package, the LED's should be kept at 30°C, 70%RH or less. The LEDs must be dip soldered within seven days(168 hours) after opening the moisture-proof packing. It is better not to use different rank LEDs. If use mixed rank, could not attain your object for highest quality of products.

