

ROUND 5MM LED LAMP

JZL-NB5H4C-E0

DATA SHEET

DOCUMENT NO.: WI-RD-LDS-NB5H4C-E0

RELEASE DATE: 2007-03-16

VERSION: A/0

MARITEX

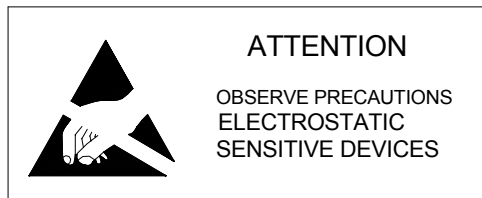

PART NO.: JZL-NB5H4C-E0

Features:

- 5mm round lamp
- Lens color: WATER CLEAR
- Emitting color: BLUE
- viewing angle: 60°
- Leads with stand-offs: No
- RoHS compliant

Application:

- Indicator
- Decoration
- keyboard
- others

Package Dimensions

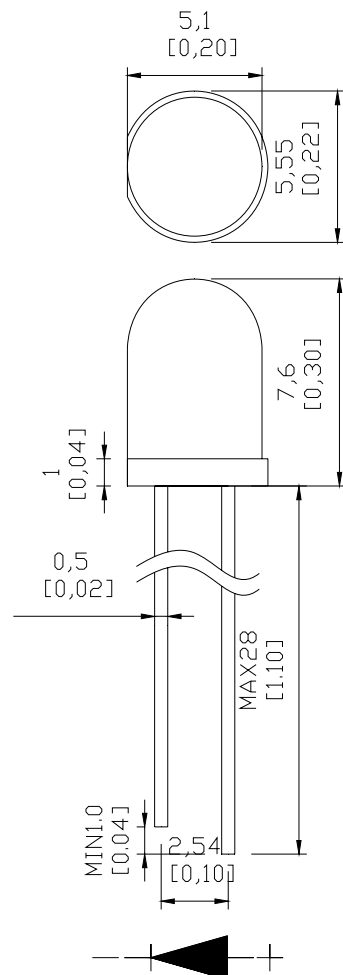

Notes:

1. All dimension are in millimeters and(Inch)tolerance is ± 0.25 mm unless otherwise noted.
2. Specifications are subject to change without notice.

PART NO.: JZL-NB5H4C-E0

Absolute Maximum Rating at $T_a=25$

Power Dissipation	120	mW
Peak Forward Current (1/10 Duty Cycle, 0.1ms Pulse Width)	120	mA
Forward Current	25	mA
Operating Temperature Range	-30°C to +85°C	
Storage Temperature Range	-40°C to +100°C	
Lead Soldering Temperature [3mm From Body]	260°C for 3 Seconds	

Electrical /Optical Characteristics at $T_a=25$

Description	Symbol	Conditions	Min.	Typ.	Max.	Unit
Forward Voltage	V _F	I _F =20mA	2.8	3.2	4.0	V
Reverse Current	I _R	V _R =5V	/	/	10	μA
Dominant Wavelength	λ _D	I _F =20mA	/	470	/	nm
Luminous Intensity	I _v	I _F =20mA	/	600	/	mcd
Half V-angle	2θ _{1/2H-H}	I _F =20mA	/	60	/	deg
	2θ _{1/2V-V}	I _F =20mA	/	/	/	deg

1. V_f maximum tolerance for each bin limit is +/-0.1V.
2. I_v maximum tolerance for each bin limit is +/-15%.
3. λ_D maximum tolerance for each bin limit is +/-1nm.

Typical Optical-Electronic Characteristic Curves

If(mA)

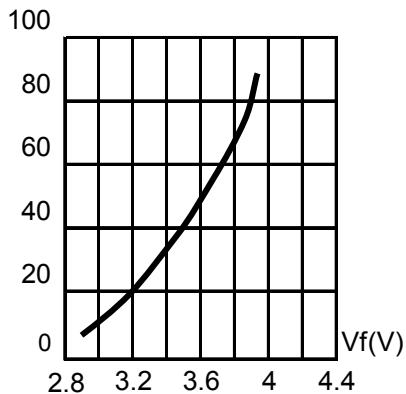

CURRENT VS. FORWARD VOLTAGE.

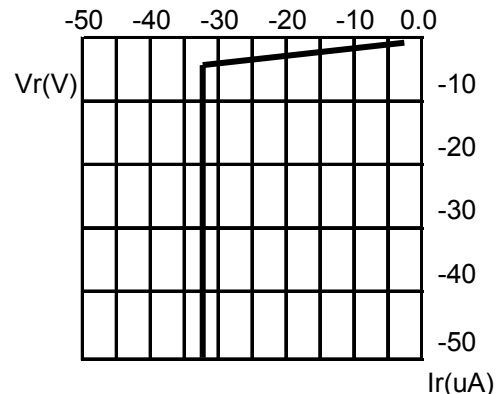

CURRENT VS. REVERSE VOLTAGE.

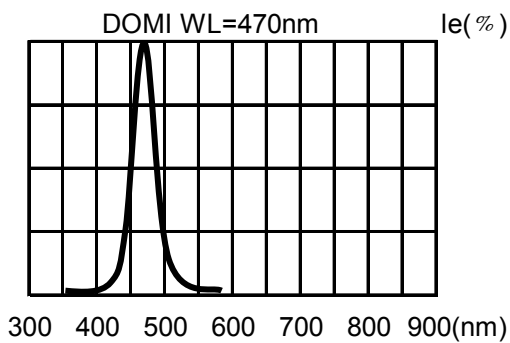
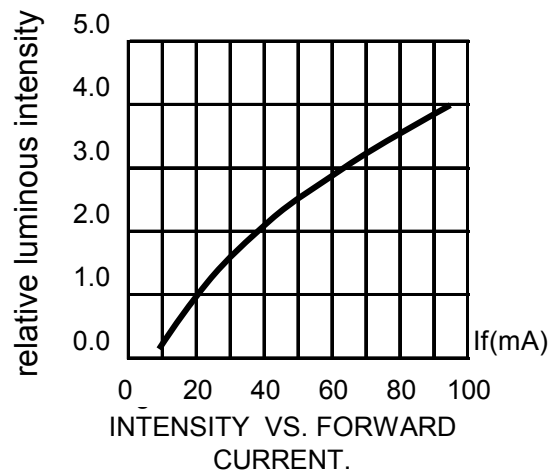

Fig.4 RELATIVE LUMINOUS INTENSITY VS. WAVELENGTH.



INTENSITY VS. FORWARD CURRENT.

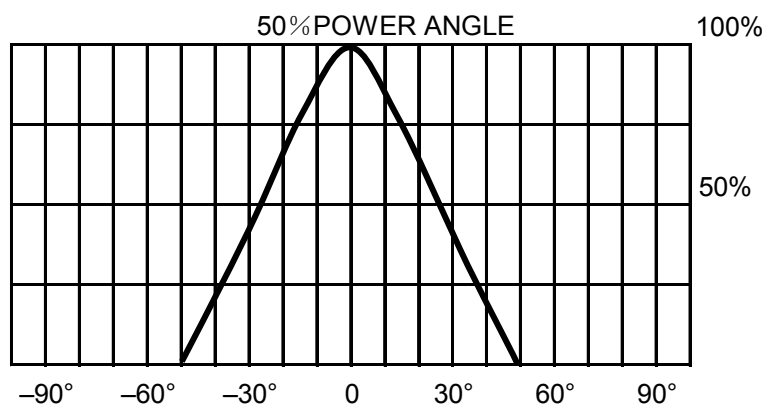

Fig.5 FAR FIELD PATTERN

CAUTIONS:

Storage time

1. The operation of Temperatures and RH are: 5°C~35°C, RH60%.
2. Once the package is opened, the products should be used within a week.
Otherwise, they should be kept in a damp proof box with desiccating agent.
Considering the tape life, we suggest our customers to use our products within a year(from production date).
3. If opened more than one week in an atmosphere 5°C~ 35°C, RH60%, they should be treated at 60°C±5 °C for 15hours.

Cleaning

Use alcohol-based cleaning solvents such as isopropyl alcohol to clean the LED.

ESD(Electrostatic Discharge)

Static Electricity or power surge will damage the LED. Use of a conductive wrist band or anti-electrostatic glove is recommended when handling these LED. All devices, equipment and machinery must be properly grounded.

Soldering Instructions

Dip and wave soldering condition: $\leq 260^{\circ}\text{C}/3\text{seconds}$, distance from solder joint to case is 3.0mm

Reliability Test:

(1) Test Items And Results

Test Item	Standard Test Method	Test Conditions	Note	Number of Damaged
Resistance to Soldering Heat	JEITA ED-4701 300 302	Tsld=260± 5°C, 10sec. 3mm from the base of the epoxy bulb	1time	0/100
Solderability	JEITA ED-4701 300 303	Tsld=235+ 5°C, 5sec. (using flux)	1time over 95%	0/100
Thermal Shock	JEITA ED-4701 300 307	-40°C/15min.~100°C/15min.	100cycles	0/100
Temperature Cycle	JEITA ED-4701 100 105	-40°C/30min.~25°C/5min. ~100°C/30min.~25°C/5min.	100cycles	0/100
Moisture Resistance Cyclic	JEITA ED-4701 200 203	25°C~65°C~-10°C 90%RH 24hrs./1cycle	10cycles	0/100
Terminal Strength(bending test)	JEITA ED-4701 400 401	Load 5N(0.5kgf) 0°~90°~0°bend 2 times	No noticeable damage	0/100
Terminal Strength(pull test)	JEITA ED-4701 400 401	Load 10N(1kgf)10+1sec.	No noticeable damage	0/100
High temperature Storage	JEITA ED-4701 200 201	Ta=100°C	1000hrs.	0/100
Temperature Humidity Storage	JEITA ED-4701 100 103	Ta=60°C, RH=90%	1000hrs.	0/100
Low Temperature Storage	JEITA ED-4701 200 202	Ta=-40°C	1000hrs.	0/100
Steady state Operating Life		Ta=25°C, IF=20mA	1000hrs.	0/100
Steady State Operating Life of High Humidity Heat		60°C, RH=90%, IF=20mA	500hrs.	0/100
Steady State Operating Life of Low Temperature		Ta=-30°C, IF=20mA	1000hrs.	0/100
Resistance to UV Beam		365nm/75W/mm	192hrs.	0/100

(2) Criteria For Judging The Damage

Item	Symbol	Test Conditions	Criteria for Judgement	
			Min.	Max.
Forward Voltage	Vf	IF=20mA	-	U.S.L.*) x 1.1
Reverse Current	Ir	VR=5V	-	U.S.L.*) x 2.0
Luminous Intensity	Iv	IF=20mA	L.S.L.**)	x 0.7

*)U.S.L.:Upper Standard Level

**)L.S.L.:Lower Standard Level