

# JZD400106YG-BW

## DATA SHEET

### 规格书

**DOCUMENT NO.:** WI-RD-LDM-400106YG-BW  
**文件编号**

**RELEASE DATE:** 2008-07-10  
**制作日期**

**VERSION:** A/0  
**版次**



#### Revised record 「变更记录」

No	Description 修改内容	Reviser 修改者	Edition 版次	Date 修改日期
1				
2				

**PART NO. 「产品型号」: JZD400106YG-BW**

**Outer Dimension 「外形尺寸」**

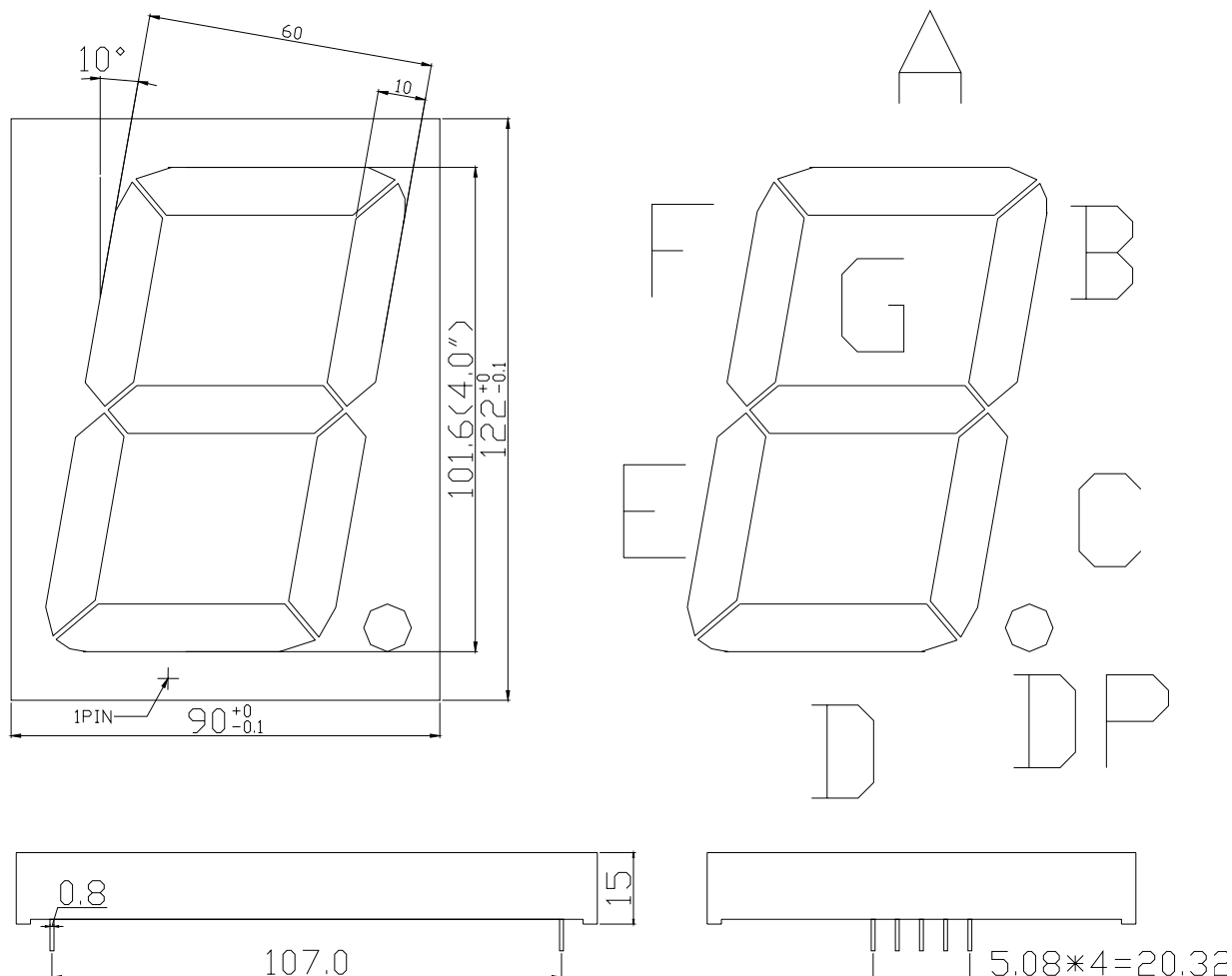

**Notes 「备注」:**

1. All dimension are in millimeters and(Inch)tolerance is  $\pm 0.25$ mm unless otherwise noted.  
所有尺寸以毫米或英寸为单位，未注明的公差  $\pm 0.25$ mm。
2. Specifications are subject to change without notice.  
规格修改恕不另行提前通知。

PART NO. 「产品型号」: JZD400106YG-BW

INTERNAL CIRCUIT DIAGRAM: 「产品内部电路图」

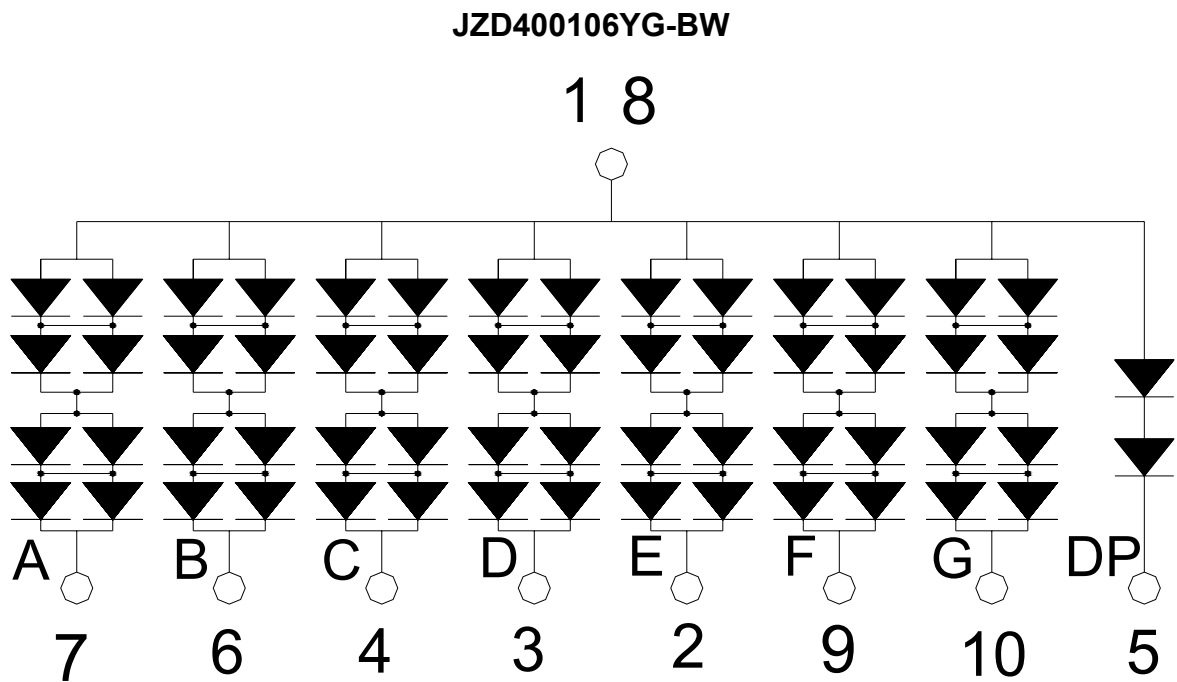

PIN CONNECTION 「PIN 连接说明」:

PIN NO.	ROW COMMON ANODE
1	Digital common anode
2	E segment cathode
3	D segment cathode
4	C segment cathode
5	Digital common anode
6	B segment cathode
7	A segment cathode
8	DP segment cathode
9	F segment cathode
10	G segment cathode

**PART NO. 「产品型号」: JZD400106YG-BW**

**DESCRIPTION 「产品描述」:**

- Black face, White segment, Bright Yellowgreen Segment Display 黑面、白胶, 黄绿色
- Common Anode 共阳,
- Dice material: AlGaIn Yellowgreen. 晶片材质: 磷化铝镓铟 黄绿色

**ELECTRICAL/OPTICAL CHARACTERISTICS AT Ta=25°C:**

「产品光电参数值, 测试环境温度为 25°C」

Parameter 参数	Symbol 符号	Test Condition 测试条件	MIN. 最小值	TYP. 典型值	MAX. 最大值	UNIT 单位
Luminous Intensity Per Segment 每段亮度	$I_v$	$I_F=20mA$	30	38	45	mcd
Dominant Wavelength 主波长	$\lambda_D$	$I_F=20mA$	571	572	573	nm
Forward Voltage Per Segment 每段正向电压	$V_F$	$I_F=20mA$	1.8	2.2	2.5	V
Reverse Current Per Segment 每段反向电流	$I_R$	$V_R=5V$	/	/	50	$\mu A$
Luminous Intensity Matching Ratio (Segment To Segment) 段与段之间亮度比	$I_{v-m}$	$I_F=20mA$	/	/	1:1.2	/

**Important Notes:**

1.  $V_f$  maximum tolerance include is  $\pm 0.1V$ . (电压最大误差  $\pm 0.1V$ )
2.  $I_v$  maximum tolerance include is  $\pm 15\%$ . (亮度最大误差  $\pm 15\%$ )
3.  $\lambda_D$  maximum tolerance include is  $\pm 1nm$ . (波长最大误差  $\pm 1nm$ )

**Absolute Maximum Rating at Ta=25℃**

「产品最大绝对参数值」

Parameter 参数	Symbol 符号	Ratings	UNIT 单位
		SGM	
Continuous Forward Current 直流电流	IF	20	mA
Peak Forward Current 脉冲电流	IFP	100	mA
Power Dissipation single 单个字节功耗	PD	45	mW
Reverse Voltage 反向电压	VR	5	V
Reverse Current Per Chip 反向电流	Ir	20	uA
Static Electricity Voltage 静电电压人体放电模式	ESD	1000	V
Operating Temperature Range 工作温度	Topr	-25~+85	℃
Storage Temperature 储存温度	Tstg	-25~+85	℃
Solder Temperature 1/16 Inch Below Seating Plane For 3 Seconds At 260℃ 在水平位置下的 1/16 英寸处焊接温度为 260℃，时间 3 秒			

**Typical Optical-Electronic Characteristic Curves**

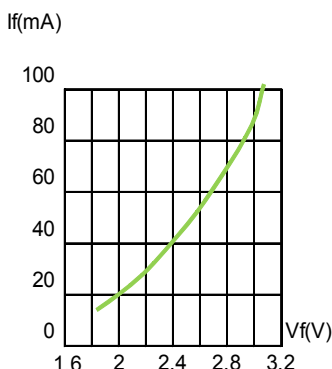

Fig.1 FORWARD CURRENT VS. FORWARD VOLTAGE.

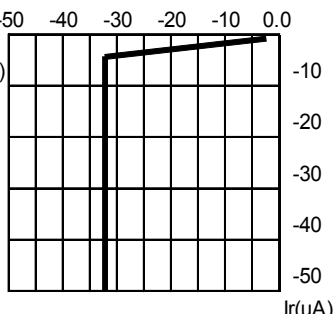
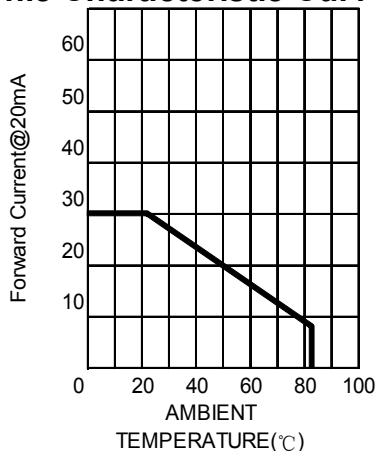

Fig.2 REVERSE CURRENT VS. REVERSE VOLTAGE.

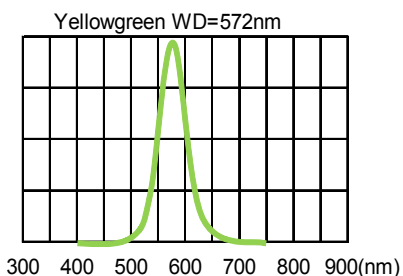

Fig.4 RELATIVE LUMINOUS INTENSITY VS. WAVELENGTH.

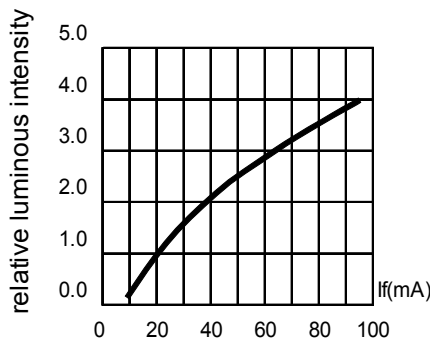

Fig.3 RELATIVE LUMINOUS INTENSITY VS. FORWARD CURRENT

**Reliability Test 「可靠性测试」：**

**(1)Test Items And Results 「测试项目和结果」**

Test Item 测试项目	Standard Test Method 测试标准	Test Conditions 测试条件	Note 备注	Number of Damaged 允收水准
Resistance to Soldering Heat 波峰焊	JEITA ED-4701 300 302	Tsld=260± 5°C,10sec. 3mm from the base of the epoxy bulb	1time	0/100
Solderability 手动焊接	JEITA ED-4701 300 303	Tsld=235± 5°C,5sec. (using flux)	1time over 95%	0/100
Thermal Shock 冷热冲击	JEITA ED-4701 300 307	-20°C/15min.~80°C/15min.	100cycles	0/100
Temperature Cycle 冷热循环	JEITA ED-4701 100 105	-40°C/30min.~25°C/5min. ~100°C/30min.~25°C/5min.	100cycles	0/100
Moisture Resistance Cyclic 耐湿循环	JEITA ED-4701 200 203	25°C~65°C~-10°C 90%RH 24hrs./1cycle	10cycles	0/100
Terminal Strength(bending test)	JEITA ED-4701 400 401	Load 5N(0.5kgf) 0°~90°~0°bend 2 times	No noticeable damage	0/100

## Jiuzhou Optoelectronics LED Technology Research Center JZD400106YG-BW

强度测试(弯曲模式)				
Terminal Strength(pull test) 强度测试(拉伸模式)	JEITA ED-4701 400 401	Load 10N(1kgf)10±1sec.	No noticeable damage	0/100
High temperature Storage 高温储存	JEITA ED-4701 200 201	Ta=100°C	1000hrs.	0/100
Temperature Humidity Storage 高温高湿储存	JEITA ED-4701 100 103	Ta=60°C,RH=90%	1000hrs.	0/100
Low Temperature Storage 低温储存	JEITA ED-4701 200 203	Ta= - 20°C	1000hrs.	0/100
Steady state Operating Life 稳定操作温度寿命		Ta=25°C,IF=20mA	1000hrs.	0/100
Steady State Operating Life of High Humidity Heat 稳定高温高湿操作温度寿命		60°C,RH=90%,IF=20mA	500hrs.	0/100
Steady State Operating Life of Low Temperature 稳定低温操作温度寿命		Ta=-20°C,IF=20mA	1000hrs.	0/100
Resistance to UV Beam 抗紫外能力		365nm/75W/mm	192hrs.	0/100

### (2)Criteria For Judging The Damage 「缺失判定标准」

Item 项目	Symbol 符号	Test Conditions 测试条件	Criteria for Judgement 判定标准	
			Min.最小值	Max.最大值
Forward Voltage	Vf	IF=20mA	-	U.S.L.*) x 1.1
Reverse Current	Ir	VR=5V	-	U.S.L.*) x 2.0
Luminous Intensity	Iv	IF=20mA	-	Initial value x 0.7
*)U.S.L:Upper Standard Level			**)L.S.L:Lower Standard Level	

**SHENZHEN JIUZHOU OPTOELECTRONICS CO., LTD.**

Add: 8/F, Jiuzhou Building, South zone of Hi-tech park Shenzhen, Nanshan district, Shenzhen, China.



**Jiuzhou Optoelectronics LED Technology Research Center**  
**JZD400106YG-BW**

---

Tel: +86 755 26947000

Fax: +86 755 2671 5369

ZIP Code:518000

[www.jz-led.com](http://www.jz-led.com)

Jiuzhou Optoelectronics and the Jiuzhou logo are trademarks of Shenzhen Jiuzhou Optoelectronics, Corporation Limited in the People`s Republic of China and other countries.

Date subject to change. Copyright©2007 Shenzhen Jiuzhou Optoelectronics Corporation Limited.

All rights reserved.

深圳九洲光电子有限公司

地址：中国深圳市南山区高新科技园南区九洲大厦 8 楼

电话：+86 755 26947000

传真：+86 755 26715369

邮编：518075

[www.jz-led.com](http://www.jz-led.com)

如需了解更多，请访问上面的网址。

九洲光电子和九洲图案标志是深圳九洲光电子有限公司在中华人民共和国和其他国家的合法注册商标。

九洲光电版权所有，保留所有权。