

# TINSHARP

TG240128A-10

## Specification For Approval

Customer Approval: \_\_\_\_\_ Date: \_\_\_\_\_

Prepared: \_\_\_\_\_ Check: \_\_\_\_\_ Approval: \_\_\_\_\_

Date: \_\_\_\_\_ Date: \_\_\_\_\_ Date: \_\_\_\_\_

**Description**

<b>REV.</b>	<b>DESCREPTION</b>	<b>DATE</b>
V00	First issue	Oct-20-2006
V01	Update DC Electrical Characteristics	Apr-29-2007
V02	Add data	Nov-01-2007

---

## CONTENTS

### 1. SPECIFICATIONS

- 1.1 Features
- 1.2 Block Diagram
- 1.3 Mechanical Specifications
- 1.4 Absolute Maximum Ratings
- 1.5 DC Electrical Characteristics
- 1.6 AC Characteristics
- 1.7 Electro-Optical Characteristics
- 1.8 Backlight Characteristics**

### 2. MODULE STRUCTURE

- 2.1 Interface Pin Description
- 2.2 Operating Principles And Methods
- 2.3 Command Definitions
- 2.4 Display Control Instructions
- 2.5 MCU And Module Connection**

### 3. RELIABILITY

- 3.1 Reliability test condition:
- 3.2 Quality Guarantee
- 3.3 Inspection method
- 3.4 Inspection Standard for Solder
- 3.5 Screen Cosmetic Criteria (Appearance)
- 3.6 Precautions for using LCM Modules
- 3.7 Installing LCM Modules
- 3.8 Precaution for Handing LCM Modules
- 3.9 Electro-Static Discharge Control
- 3.10 Precaution for soldering to the LCM
- 3.11 Precautions for operation
- 3.12 Storage
- 3.13 Safety
- 3.14 Limited Warranty
- 3.15 Return LCM under warranty**

### 4 . DATE CODE RULES

- 4.1 Date code for sample
- 4.2 Date code for production

# 1 . SPECIFICATIONS

## 1.1 FEATURES

Item	Contents	Unit
LCD type	STN/Transmissive/Negative/Blue	--
LCD duty	1/128	--
LCD bias	1/12	--
Viewing direction	12	o'clock
Module size(W x H x T)	144.0 X 104.0 X 13.2	mm
Viewing area(W x H)	114.0 X 64.0	mm
Number of dots	240 X 128	dots
Dots size(W x H)	0.4 X 0.4	mm
Dots pitch(W x H)	0.45 X 0.45	mm

## 1.2. BLOCK DIAGRAM

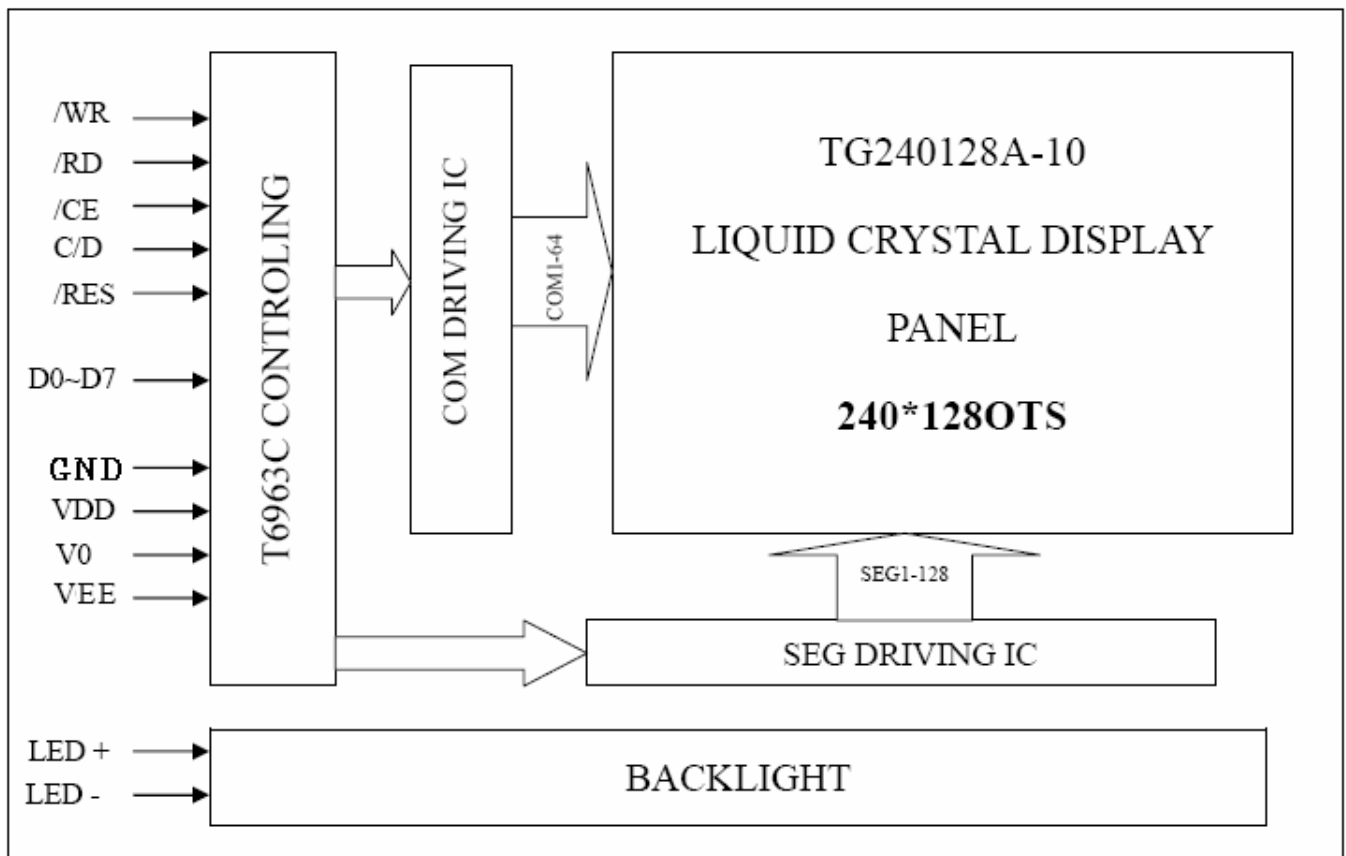

1.3. MECHANICAL SPECIFICATION

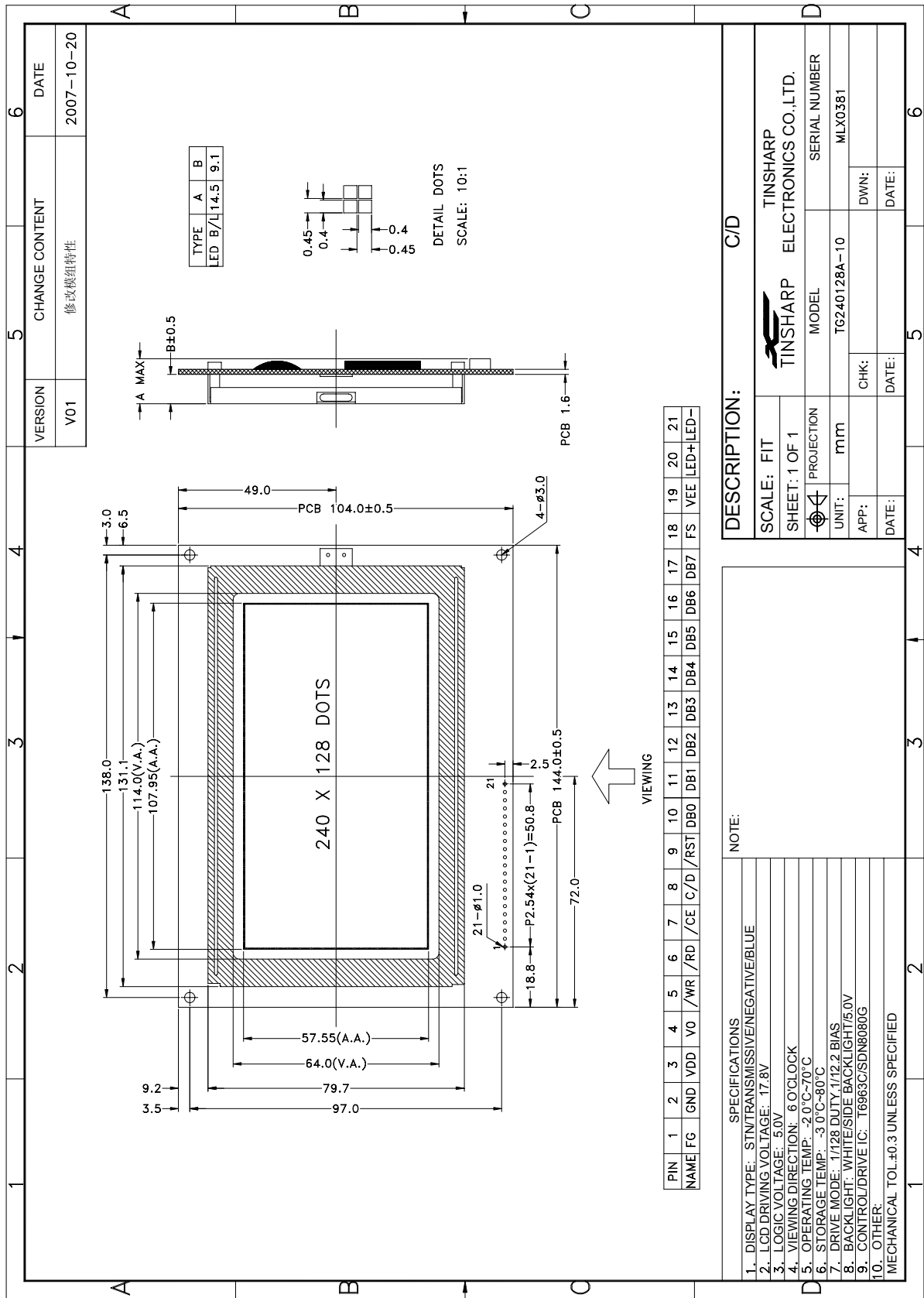

### 1.4 ABSOLUTE MAXIMUM RATINGS ( Ta = 25°C )

Parameter	Symbol	Min	Max	Unit
Supply voltage for logic	V <sub>DD</sub>	-0.3	7.0	V
Input voltage	V <sub>IN</sub>	-0.3	V <sub>DD</sub> +0.3	V
Normal Operating temperature	T <sub>OP</sub>	-20	+70	°C
Normal Storage temperature	T <sub>ST</sub>	-30	+80	°C

### 1.5 DC ELECTRICAL CHARACTERISTICS

( VSS=0V, Ta = 25°C )

Parameter	Symbol	Condition	Min	Typ.	Max	Unit
Supply voltage for logic	V <sub>DD</sub>	--	-	5.0	-	V
Supply current for logic	I <sub>DD</sub>	--	--	25	-	mA
Operating voltage for LCD	V <sub>lcd</sub>	25°C	-	17.8	-	V
Input voltage "H" level	V <sub>IH</sub>	--	0.7 V <sub>DD</sub>	--	V <sub>DD</sub>	V
Input voltage "L" level	V <sub>IL</sub>	--	0	--	0.3V <sub>DD</sub>	V

### 1.6 AC CHARACTERISTICS

MPU Interface Timing

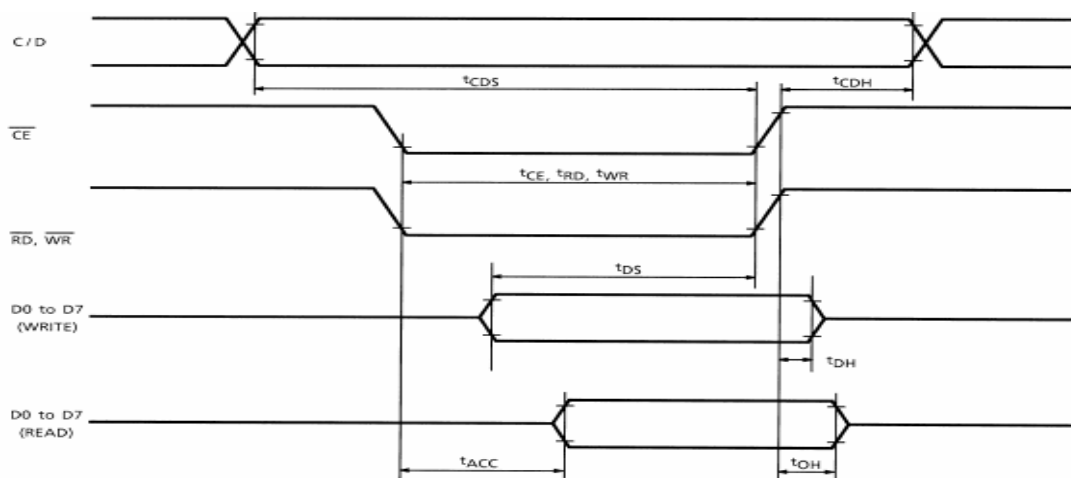

Test Conditions (Unless Otherwise Noted, V<sub>DD</sub> = 5.0 V ± 10%, V<sub>SS</sub> = 0 V, Ta = -20 to 70°C)

Item	Symbol	Test Conditions	Min	Max	Unit
C / D Set-up Time	t <sub>CDS</sub>	—	100	—	ns
C / D Hold Time	t <sub>CDH</sub>	—	10	—	ns
CE, RD, WR Pulse Width	t <sub>CE, tRD, tWR</sub>	—	80	—	ns
Data Set-up Time	t <sub>DS</sub>	—	80	—	ns
Data Hold Time	t <sub>DH</sub>	—	40	—	ns
Access Time	t <sub>ACC</sub>	—	—	150	ns
Output Hold Time	t <sub>OH</sub>	—	10	50	ns

### 1.7 ELECTRO-OPTICAL CHARACTERISTICS

ITEM	SYMBOL	CONDITION	MIN	TYP	MAX	UNIT	NOTE
Contrast ratio	K	$\theta=0, \Phi=0$	-	2	-		2
Response time(rise)	Tr	25°C		-	-	ms	1
Response time(fall)	Tf			-	-		1
Viewing angle	$\Phi$	25°C		-		deg.	3
	$\theta$			-			3

Note1: Definition of response time.

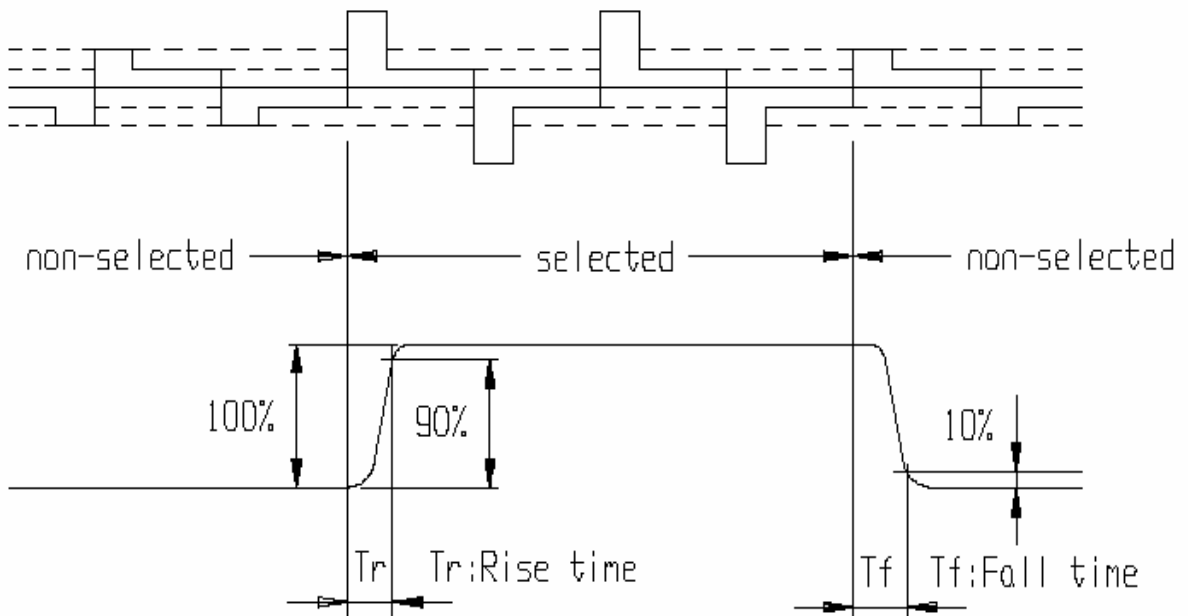

Note2: Definition of contrast ratio 'Cr' .

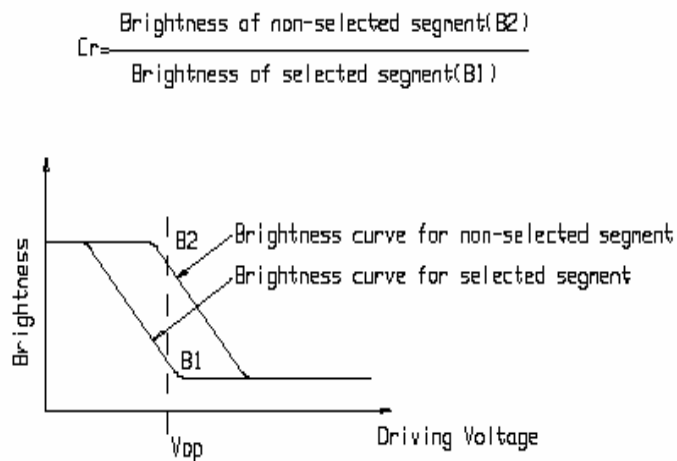

Note3: Definition of viewing angle range 'θ'.

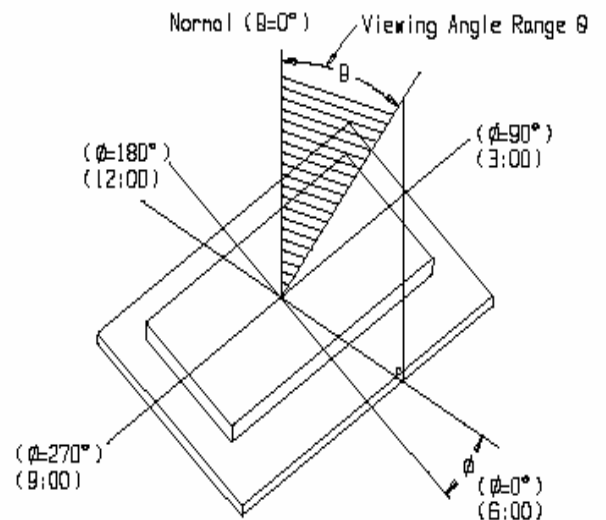

## 1.8 BACKLIGHT CHARACTERISTICS

### 1.8.1 ABSOLUTE MAXIMUM RATINGS(Ta=25°C)

Item	Symbol	Conditions	Rating	Unit
Reverse voltage	$V_r$		5	V
Reverse Current	$I_r$	$V_r=5.0v$	120	$\mu A$
Absolute maximum forward current	$I_{fm}$		250	mA
Peak forward current	$I_{fp}$	1 msec plus 10% Duty Cycle	720	mA
Power dissipation	$P_d$		840	mW
Operating Temperature Range	$T_{oper}$		-20~+70°C	°C
Storage Temperature Range	$T_{st}$		-30~+80°C	°C

### 1.8.2 ELECTRICAL –OPTICAL CHARACTERISTICS(Ta=25°C,If=180mA)

Color	Wavelength $\lambda_p$ (nm)	Operating voltage(V) ( $\pm 0.2V$ )	Forward Current (mA)
White	white	3.2	180

## 2. MODULE STRUCTURE

### 2.1. INTERFACE PIN CONNECTIONS

Pin No.	Symbol	Level	Description
1	FG	0V	Frame ground.
2	VSS	0V	Ground.
3	VDD	+5.0V	Supply voltage for logic operating.
4	V0	--	Adjusting LCD contrast.
5	/WR	H/L	Write enable signal.
6	/RD	H/L	Read enable signal.
7	/CS	H/L	Chip enable signal, low level is active.
8	C/D	H/L	C/D=H: D0 to D7 are display control data. C/D=L: D0 to D7 are display data.
9	/RST	H/L	Reset signal, low level is active.
10	DB0	H/L	8-bit bi-directional data bus.
11	DB1		
12	DB2		
13	DB3		
14	DB4		
15	DB5		
16	DB6		
17	DB7		
18	FS	H/L	Font selection. FS=L:8*8. FS=H:6*8
19	VEE	--	Internal negative voltage to LCD driving.
20	LED+	+5.0V	Power supply for Backlight

21	LED-	0V	The backlight ground.
----	------	----	-----------------------

## 2.2.OPERATING PRINCIPLE AND METHODS

### (1) Status Read

A status check must be performed before data is read or written.

Status check

The Status of T6963C can be read from the data lines.

/RD           L  
 /WR           H  
 /CE           L  
 C / D         H  
 D0 to D7     Status word

The T6963C status word format is as follows:

MSB				LSB			
STA7 D7	STA6 D6	STA5 D5	STA4 D4	STA3 D3	STA2 D2	STA1 D1	STA0 D0
STA0	Check command execution capability					0: Disable 1: Enable	
STA1	Check data read / write capability					0: Disable 1: Enable	
STA2	Check Auto mode data read capability					0: Disable 1: Enable	
STA3	Check Auto mode data write capability					0: Disable 1: Enable	
STA4	Not used						
STA5	Check controller operation capability					0: Disable 1: Enable	
STA6	Error flag. Used for Screen Peek and Screen copy commands.					0: No error 1: Error	
STA7	Check the blink condition					0: Display off 1: Normal display	

Note 1: It is necessary to check STA0 and STA1 at the same time.

There is a possibility of erroneous operation due to a hardware interrupt.

Note 2: For most modes STA0 / STA1 are used as a status check.

Note 3: STA2 and STA3 are valid in Auto mode; STA0 and STA1 are invalid.

### Status checking flow

a)

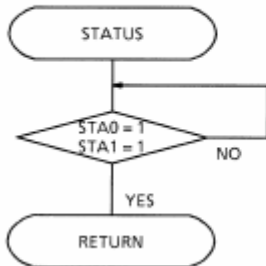

b)

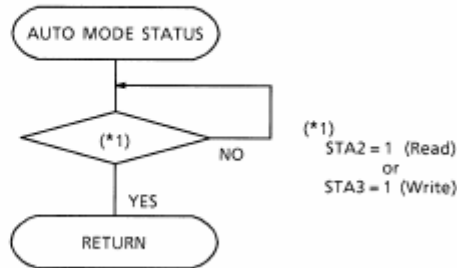

Note 4: When using the MSB = 0 command, a Status Read must be performed.

If a status check is not carried out, the T6963C cannot operate normally, even after a delay time.

The hardware interrupt occurs during the address calculation period (at the end of each line).

If a MSB = 0 command is sent to the T6963C during this period, the T6963C enters Wait status.

If a status check is not carried out in this state before the next command is sent, there is the possibility that the command or data will not be received.

### (2) Setting data

When using the T6963C, first set the data, then set the command.

#### Procedure for sending a command

a) The case of 1 data



b) The case of 2 data

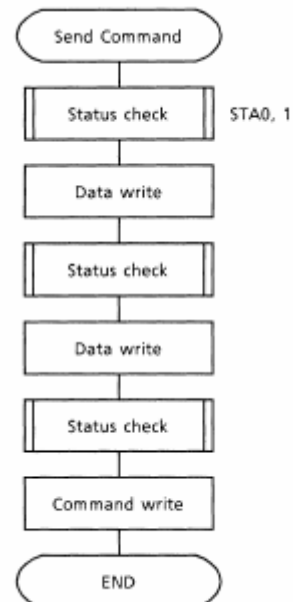

Note: When sending more than two data, the last datum (or last two data) is valid.

**2.3. COMMAND DEFINITIONS**

Command	Code	D1	D2	Function
REGISTERS SETTING	00100001 00100010 00100100	X address Data Low address	Y address 00H High address	Set Cursor Pointer Set Offset Register Set Address Pointer
SET CONTROL WORD	01000000 01000001 01000010 01000011	Low address Columns Low address Columns	High address 00H High address 00H	Set Text Home Address Set Text Area Set Graphic Home Address Set Graphic Area
MODE SET	1000X000 1000X001 1000X011 1000X100 10000XXX 10001XXX	— — — — — —	— — — — — —	OR mode EXOR mode AND mode Text Attribute mode Internal CG ROM mode External CG RAM mode
DISPLAY MODE	10010000 1001XX10 1001XX11 100101XX 100110XX 100111XX	— — — — — —	— — — — — —	Display off Cursor on, blink off Cursor on, blink on Text on, graphic off Text off, graphic on Text on, graphic on
CURSOR PATTERN SELECT	10100000 10100001 10100010 10100011 10100100 10100101 10100110 10100111	— — — — — — — —	— — — — — — — —	1-line cursor 2-line cursor 3-line cursor 4-line cursor 5-line cursor 6-line cursor 7-line cursor 8-line cursor
DATA AUTO READ / WRITE	10110000 10110001 10110010	— — —	— — —	Set Data Auto Write Set Data Auto Read Auto Reset
DATA READ / WRITE	11000000 11000001 11000010 11000011 11000100 11000101	Data — Data — Data —	— — — — — —	Data Write and Increment ADP Data Read and Increment ADP Data Write and Decrement ADP Data Read and Decrement ADP Data Write and Nonvariable ADP Data Read and Nonvariable ADP
SCREEN PEEK	11100000	—	—	Screen Peek
SCREEN COPY	11101000			Screen Copy
BIT SET / RESET	11110XXX 11111XXX 1111X000 1111X001 1111X010 1111X011 1111X100 1111X101 1111X110 1111X111	— — — — — — — — — —	— — — — — — — — — —	Bit Reset Bit Set Bit 0 (LSB) Bit 1 Bit 2 Bit 3 Bit 4 Bit 5 Bit 6 Bit 7 (MSB)

## 2.4. DISPLAY CONTROL INSTRUCTION

### 2.4.1. Setting registers

Code	Hex.	Function	D1	D2
00100001	21H	SET CURSOR POINTER	X ADRS	Y ADRS
00100010	22H	SET OFFSET REGISTER	DATA	00H
00100100	24H	SET ADDRESS POINTER	LOW ADRS	HIGH ADRS

#### (1) Set Cursor Pointer

The position of the cursor is specified by X ADRS and Y ADRS. The cursor position can only be moved by this command. Data read / write from the MPU never changes the cursor pointer. X ADRS and Y ADRS are specified as follows.

X ADRS 00H to 4FH (lower 7 bits are valid)

Y ADRS 00H to 1FH (lower 5 bits are valid)

#### a) Single Scan

X ADRS 00 to 4FH

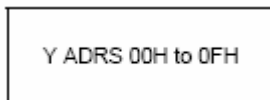

#### b) Dual Scan

X ADRS 00H to 4FH

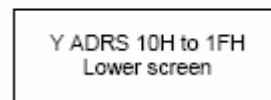
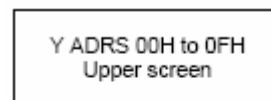

#### (2) Set Offset Register

The offset register is used to determine the external character generator RAM area.

The T6963C has a 16-bit address bus as follows:

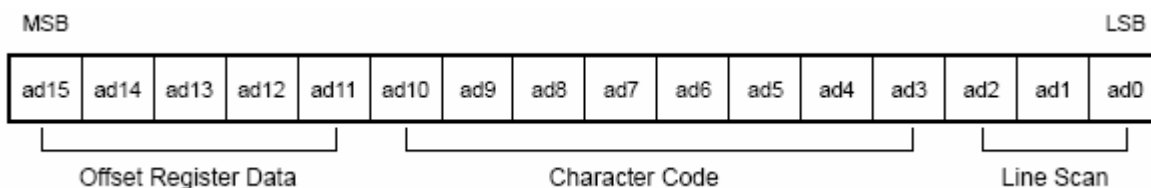

T6963C assign External character generator, when character code set 80H to FFH in using internal character generator. Character code 00H to 80H assign External character generator, when External generator mode.

The senior five bits define the start address in external memory of the CG RAM area. The next eight bits represent the character code of the character. In internal CG ROM mode, character codes 00H to 7FH represent the predefined “internal” CG ROM characters, and codes 80H to FFH represent the user’s own “external” characters. In external CG RAM mode, all 256 codes from 00H to FFH can be used to represent the user’s own characters. The three least significant bits indicate one of the eight rows of eight dots that define the character’s shape.

The relationship between display RAM address and offset register

Offset register data	CG RAM hex. address (start to end)
00000	0000 to 07FFH
00001	0800 to 0FFFH
00010	1000 to 17FFH
11100	E000 to E7FFH
11101	E800 to EFFFH
11110	F000 to F7FFH
11111	F800 to FFFFH

(Example 1)

Offset register	02H				
Character code	80H				
Character generator RAM start address	0001	0100	0000	0000	
	1	4	0	0	H

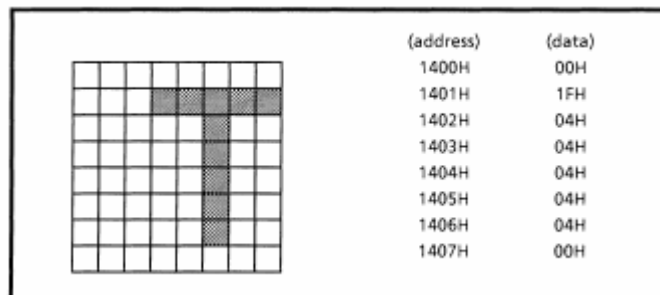

(Example 2) The relationship between display RAM data and display characters

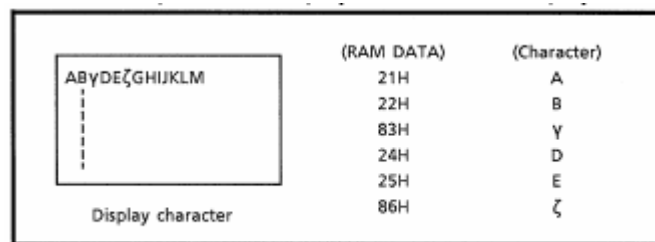

γ and ζ are displayed by character generator RAM.

### 3) Set Address Pointer

The Set Address Pointer command is used to indicate the start address for writing to (or reading from) external RAM.

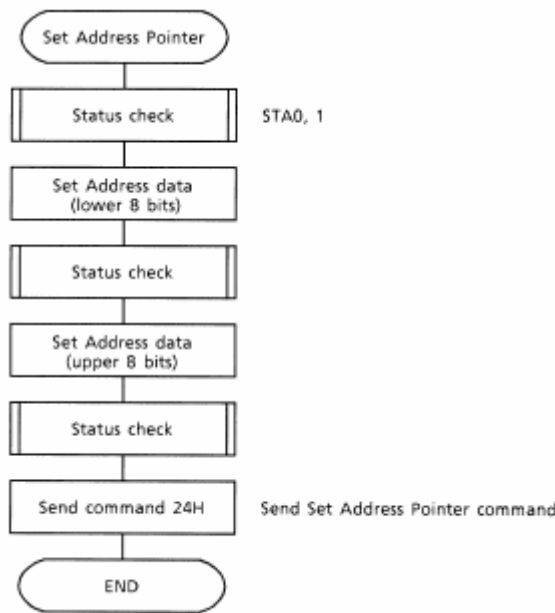
**The Flowchart for Set Address Pointer command**

**2.4.2. Set Control Word**

Code	Hex.	Function	D1	D2
01000000	40H	Set Text Home Address	Low address	High address
01000001	41H	Set Text Area	Columns	00H
01000010	42H	Set Graphic Home Address	Low address	High address
01000011	43H	Set Graphic Area	Columns	00H

The home address and column size are defined by this command.

**(1) Set Text Home Address**

The starting address in the external display RAM for text display is defined by this command. The text home address indicates the leftmost and uppermost position.

The relationship between external display RAM address and display position

TH		TH + CL
TH + TA		TH + TA + CL
(TH + TA) + TA		TH + 2TA + CL
(TH + 2TA) + TA		TH + 3TA + CL
TH + (n - 1) TA		TH + (n - 1) TA + CL

TH: Text home address

TA: Text area number (columns)

CL: Columns are fixed by hardware (pin-programmable).

(Example)

Text home address : 0000H

Text area: 0020H

MD2 = H, MD3 = H : 32 columns

DUAL = H, MDS = L, MD0 = L, MD1 = H : 4 lines

0000H	0001H		001EH	001FH
0020H	0021H		003EH	002FH
0040H	0041H		005EH	005FH
0060H	0061H		007EH	007FH

## (2) Set Graphic Home Address

The starting address of the external display RAM used for graphic display is defined by this command.

The graphic home address indicates the leftmost and uppermost position.

The relationship between external display RAM address and display position

GH		GH + CL
GH + GA		GH + GA + CL
(GH + GA) + GA		GH + 2GA + CL
(GH + 2GA) + GA		GH + 3GA + CL
GH + (n - 1) GA		GH + (n - 1) GA + CL

GH: Graphic home address

GA: Graphic area number (columns)

CL: Columns are fixed by hardware (pin-programmable).

(Example)

Graphic home address: 0000H    Graphic area : 0020H

MD2 = H, MD3 = H 32 columns    DUAL = H, MDS = L, MD0 = H, MD1 = H : 2 lines

0000H	0001H		001EH	001FH
0020H	0021H		003EH	003FH
0040H	0041H		005EH	005FH
0060H	0061H		007EH	007FH
0080H	0081H		009EH	009FH
00A0H	00A1H		00BEH	00BFH
00C0H	00C1H		00DEH	00DFH
00E0H	00E1H		00FEH	00FFH
0100H	0101H		011EH	011FH
0120H	0121H		013EH	013FH
0140H	0141H		015EH	015FH
0160H	0161H		017EH	017FH
0180H	0181H		019EH	019FH
01A0H	01A1H		01BEH	01BFH
01C0H	01C1H		01DEH	01DFH
01E0H	01E1H		01FEH	01FFH

**(3) Set Text Area**

The display columns are defined by the hardware setting. This command can be used to adjust the columns of the display.

(Example)

LCD size : 20 columns, 4 lines  
 Text home address : 0000H  
 Text area : 0014H  
 MD2 = H, MD3 = H : 32 columns  
 DUAL = H, MDS = L, MD0 = L, MD1 = H : 4 lines

0000	0001	.....	0013	0014	.....	001F
0014	0015	.....	0027	0028	.....	0033
0028	0029	.....	003B	003C	.....	0047
003C	003D	.....	004F	0050	.....	005B

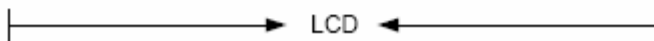

**(4) Set Graphic Area**

The display columns are defined by the hardware setting. This command can be used to adjust the columns of the graphic display.

(Example)

LCD size : 20 columns, 2 lines  
 Graphic home address : 0000H  
 Graphic area : 0014H  
 MD2 = H, MD3 = H : 32 columns  
 DUAL = H, MDS = L, MD0 = H, MD1 = H : 2 lines

0000	0001	.....	0013	0014	.....	001F
0014	0015	.....	0027	0028	.....	0033
0028	0029	.....	003B	003C	.....	0047
003C	003D	.....	004F	0050	.....	005B
0050	0051	.....	0063	0064	.....	006F
0064	0065	.....	0077	0078	.....	0083
0078	0079	.....	008B	008C	.....	0097
008C	008D	.....	009F	00A0	.....	00AB
00A0	00A1	.....	00B3	00B4	.....	00BF
00B4	00B5	.....	00C7	00C8	.....	00D3
00C8	00C9	.....	00DB	00DC	.....	00E7
00DC	00DD	.....	00EF	00F0	.....	00FD
00F0	00F1	.....	0103	0104	.....	011F
0104	0105	.....	0127	0128	.....	0123
0128	0129	.....	013B	013C	.....	0147
013C	013D	.....	014F	0150	.....	015B

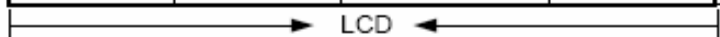

If the graphic area setting is set to match the desired number of columns on the LCD, the addressing scheme will be automatically modified so that the start address of each line equals the end address of the previous line + 1.

### 2.4.3. Mode set

Code	Function	Operand
1000X000	OR Mode	—
1000X001	EXOR Mode	—
1000X011	AND Mode	—
1000X100	TEXT ATTRIBUTE Mode	—
10000XXX	Internal Character Generator Mode	—
10001XXX	External Character Generator Mode	—

X: invalid

The display mode is defined by this command. The display mode does not change until the next command is sent. The logical OR, EXOR, AND of text or graphic display can be displayed. In Internal Character Generator mode, character codes 00H to 7FH are assigned to the built-in character generator ROM. The character codes 80H to FFH are automatically assigned to the external character generator RAM.

(Example)

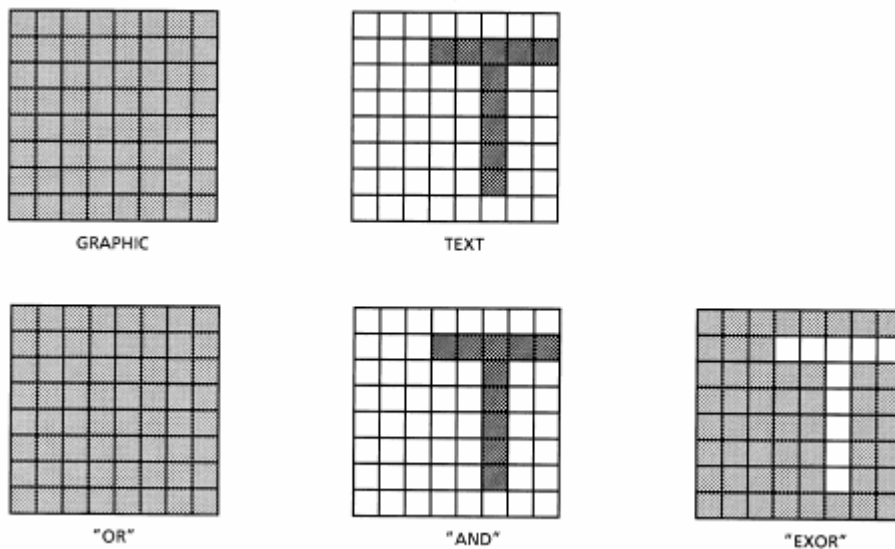

Note: Attribute functions can only be applied to text display, since the attribute data is placed in the graphic RAM area.

**Attribute function**

The attribute operations are Reverse display, Character blink and Inhibit. The attribute data is written into the graphic area which was defined by the Set Control Word command. Only text display is possible in Attribute Function mode; graphic display is automatically disabled. However, the Display Mode command must be used to turn both Text and Graphic on in order for the Attribute function to be available.

The attribute data for each character in the text area is written to the same address in the graphic area. The Attribute function is defined as follows.

Attribute RAM 1byte

X	X	X	X	d3	d2	d1	d0
---	---	---	---	----	----	----	----

d3	d2	d1	d0	Function	
0	0	0	0	Normal display	
0	1	0	1	Reverse display	
0	0	1	1	Inhibit display	
1	0	0	0	Blink of normal display	
1	1	0	1	Blink of reverse display	X: invalid
1	0	1	1	Blink of inhibit display	

**2.4.4. Display mode**

Code	Function	Operand	
10010000	Display off	—	
1001XX10	Cursor on, blink off	—	
1001XX11	Cursor on, blink on	—	
100101XX	Text on, graphic off	—	
100110XX	Text off, graphic on	—	X: invalid
100111XX	Text on, graphic on	—	

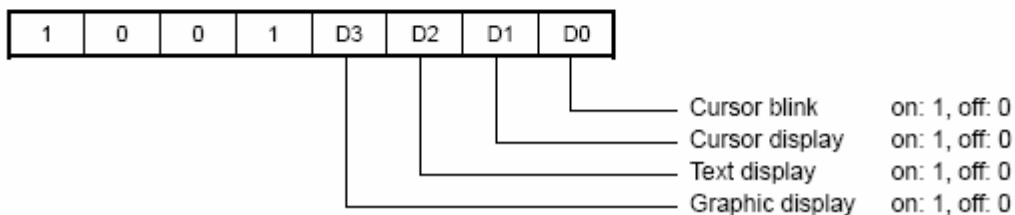

Note: It is necessary to turn on “Text display” and “Graphic display” in the following cases.

- a) Combination of text / graphic display
- b) Attribute function

### 2.4.5 Cursor pattern select

Code	Function	Operand
10100000	1-line cursor	—
10100001	2-line cursor	—
10100010	3-line cursor	—
10100011	4-line cursor	—
10100100	5-line cursor	—
10100101	6-line cursor	—
10100110	7-line cursor	—
10100111	8-line cursor	—

When cursor display is ON, this command selects the cursor pattern in the range 1 line to 8 lines. The cursor address is defined by the Cursor Pointer Set command.

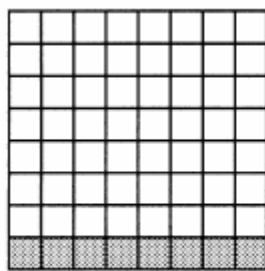

1-line cursor

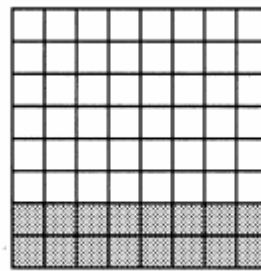

2-line cursor

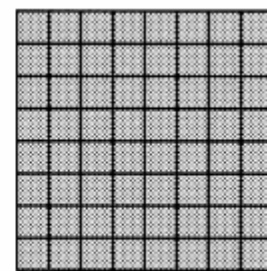

8-line cursor

### 2.4.6 Data Auto Read /Write

Code	Hex.	Function	Operand
10110000	B0H	Set Data Auto Write	—
10110001	B1H	Set Data Auto Read	—
10110010	B2H	Auto Reset	—

This command is convenient for sending a full screen of data from the external display RAM. After setting Auto mode, a Data Write (or Read) command is need not be sent between each datum. A Data Auto Write (or Read) command must be sent after a Set Address Pointer command. After this command, the address pointer is automatically incremented by 1 after each datum. In Auto mode, the T6963C cannot accept any other commands. The Auto Reset command must be sent to the T6963C after all data has been sent, to clear Auto mode.

Note: A Status check for Auto mode

(STA2, STA3 should be checked between sending of each datum. Auto Reset should be performed after checking STA3 = 1 (STA2 = 1). Refer to the following flowchart.

a) Auto Read mode

b) Auto Write mode

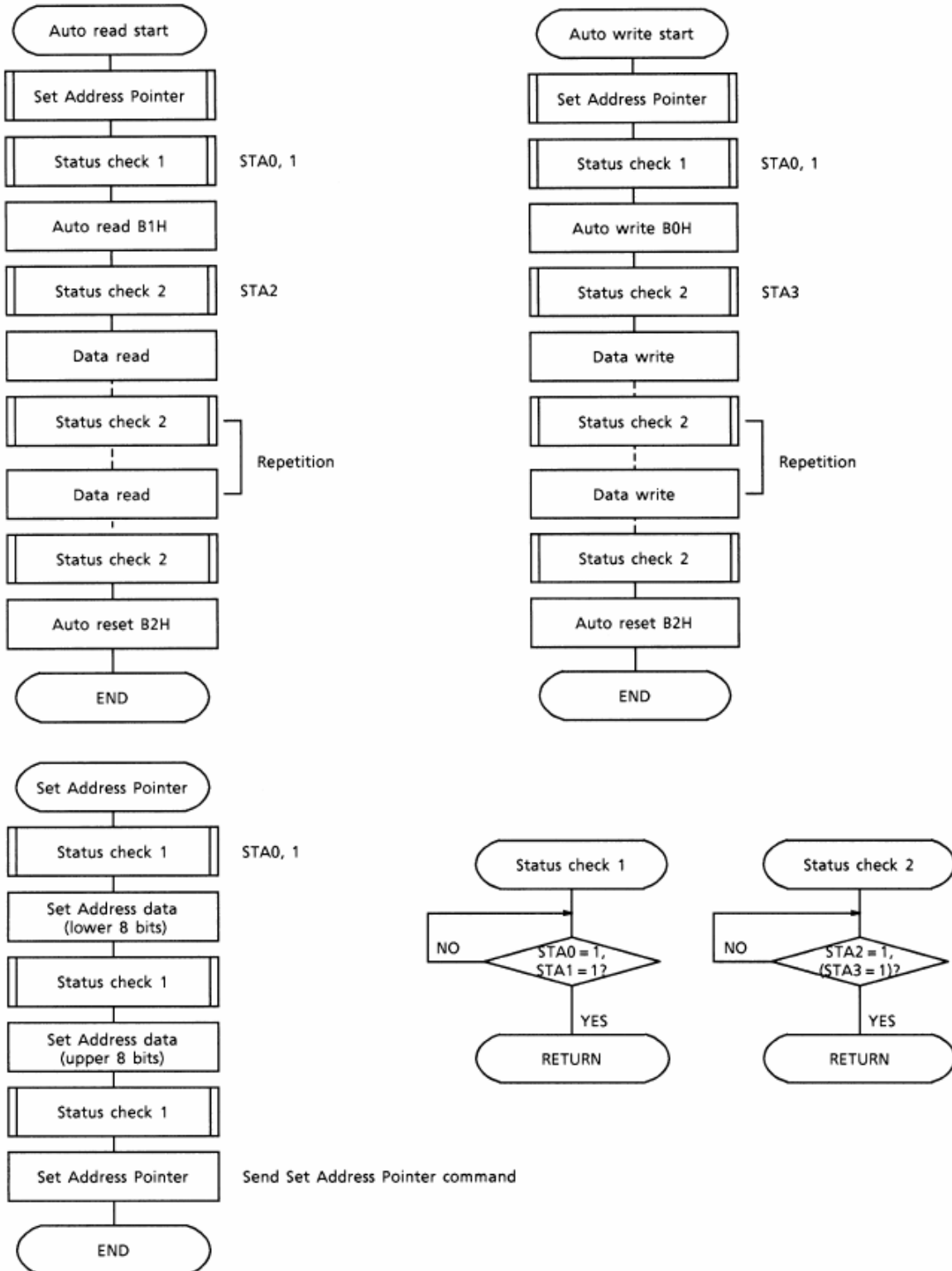

2.4.7 Data Read / Write

Code	Hex.	Function	Operand
11000000	C0H	Data Write and Increment ADP	Data
11000001	C1H	Data Read and Increment ADP	—
11000010	C2H	Data Write and Decrement ADP	Data
11000011	C3H	Data Read and Decrement ADP	—
11000100	C4H	Data Write and Nonvariable ADP	Data
11000101	C5H	Data Read and Nonvariable ADP	—

This command is used for writing data from the MPU to external display RAM, and reading data from external display RAM to the MPU. Data Write / Data Read should be executed after setting address using Set Address Pointer command. The address pointer can be automatically incremented or decremented using this command.

Note: This command is necessary for each 1-byte datum.

Refer to the following flowchart.

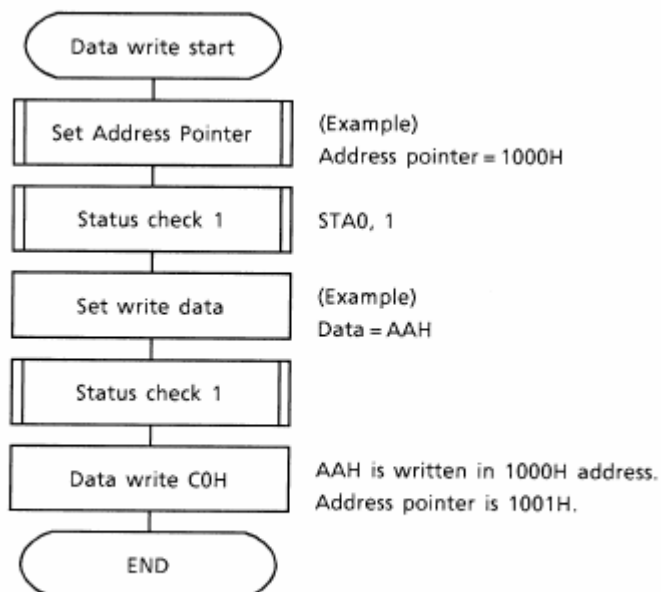

2.4.8 Screen Peek

Code	Hex.	Function	Operand
11100000	E0H	Screen Peek	—

This command is used to transfer 1 byte of displayed data to the data stack; this byte can then be read from the MPU by data access. The logical combination of text and graphic display data on the LCD screen can be read by this command.

The status (STA6) should be checked just after the Screen Peek command. If the address determined by the Set Address Pointer command is not in the graphic area, this command is ignored and a status flag (STA6) is set.

Refer to the following flowchart.

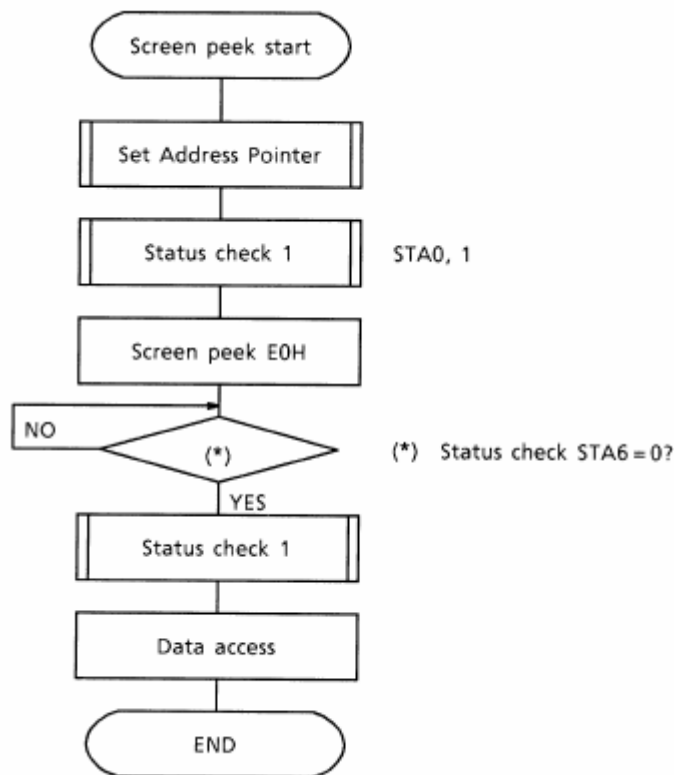

Note: This command is available when hardware column number and software column number are the same.

Hardware column number is related to MD2 and MD3 setting.

Software column number is related to Set Text Area and Set Graphic Area command.

2.4.9 Screen Copy

Code	Hex.	Function	Operand
11101000	E8H	Screen Copy	—

This command copies a single raster line of data to the graphic area.

The start point must be set using the Set Address Pointer command.

Note 1: If the attribute function is being used, this command is not available.

(With Attribute data is graphic area data.)

Note 2: With Dual-Scan, this command cannot be used (because the T6963C cannot separate the upper screen data and lower screen data).

Refer to the following flowchart.

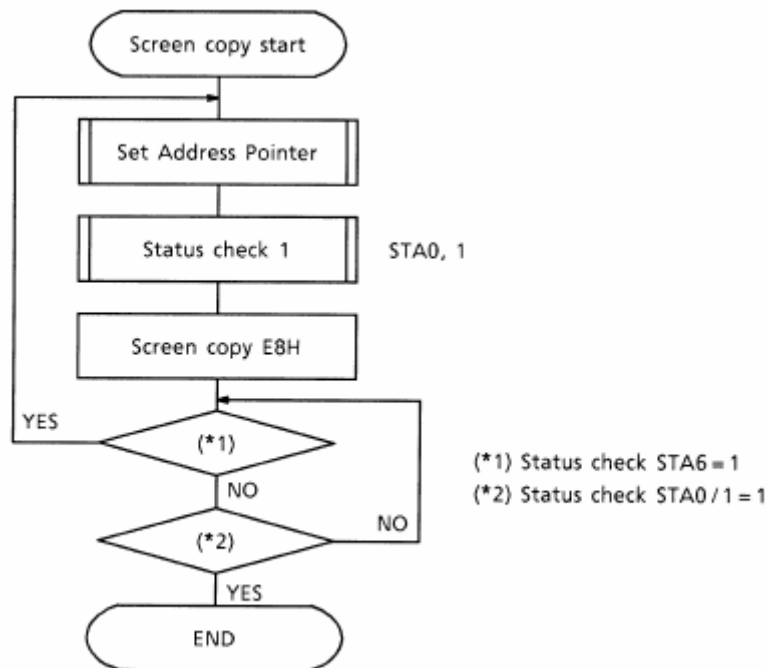

Note: This command is available when hardware column number and software column number are the same.

Hardware column number is related to MD2 and MD3 setting.

Software column number is related to Set Text Area and Set Graphic Area command.

2.4.10 Bit Set/Reset

Code	Function	Operand
11110XXX	Bit Reset	—
11111XXX	Bit Set	—
1111X000	Bit 0 (LSB)	—
1111X001	Bit 1	—
1111X010	Bit 2	—
1111X011	Bit 3	—
1111X100	Bit 4	—
1111X101	Bit 5	—
1111X110	Bit 6	—
1111X111	Bit 7 (MSB)	—

X: invalid

This command use to set or reset a bit of the byte specified by the address pointer. Only one bit can be set / reset at a time.

Refer to the following flowchart.

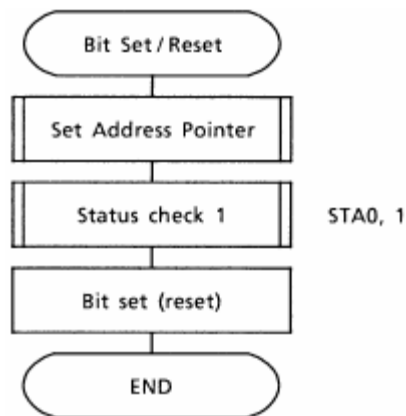

Character Code Map

The relation between character codes and character pattern (CG ROM TYPE 0101)

MSB \ LSB	0	1	2	3	4	5	6	7	8	9	A	B	C	D	E	F
0																
1																
2																
3																
4																
5																
6																
7																

The relation between character codes and character pattern (CG ROM TYPE 0201)

MSB \ LSB	0	1	2	3	4	5	6	7	8	9	A	B	C	D	E	F
0																
1																
2																
3																
4																
5																
6																
7																

**2.5. MCU AND MODULE CONNECTION**

(For reference only)

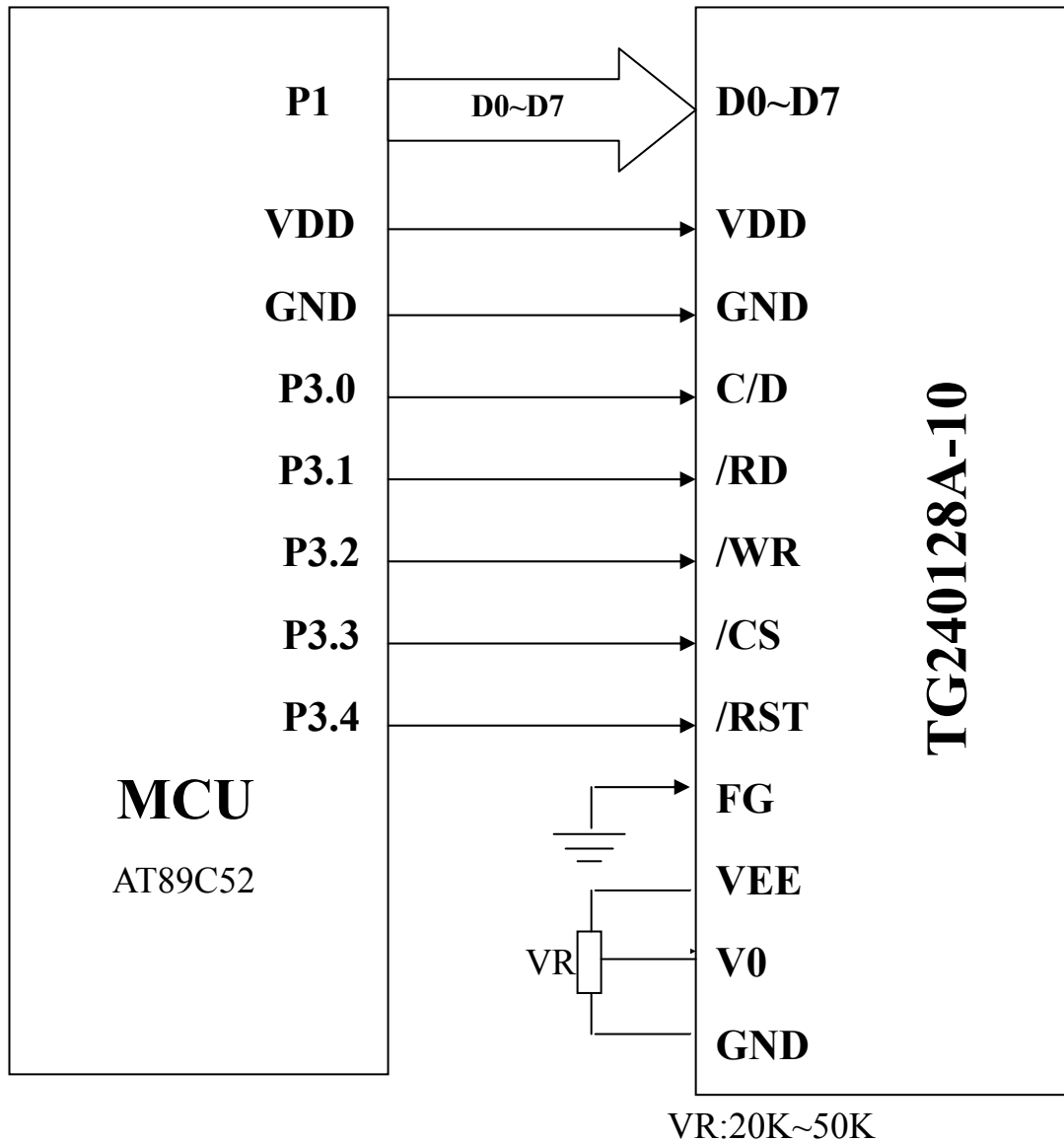

### 3. RELIABILITY TEST AND QUALITY

#### 3.1. RELIABILITY TEST CONDITION

No.	TEST Item	Content of Test	Test Condition	Applicable Standard
1	High temperature storage	Endurance test applying the high storage temperature for a long time.	80° C 96hrs	-----
2	Low temperature operation	Endurance test applying the low storage Temperature for a long time	-30° C 96hrs	-----
3	High temperature operation	Endurance test applying the electric stress (Voltage & current)and the thermal stress to the element for a long time	70° C 96hrs	-----
4	Low temperature operation	Endurance test applying the electric stress Under low temperature for a long time	-20° C 96hrs	-----
5	High temperature/ Humidity operation	Endurance test applying the electric stress(Voltage & current) and Temperature/ Humidity stress to the element for a long time	70° C 90%RH 96hrs	
6	High temperature/ Humidity operation	Endurance test applying the electric stress (voltage & current)and temperature/ humidity stress to the element for a long time	65° C 90%RH 96hrs	
7	Temperature cycle	Endurance test applying the low and high temperature cycle. -20° C →25° C→70° C 30min←5min←30min.(1 cycle)	-20° C/70° C 10 cycle	-----

Supply voltage for logic system = 5V. Supply voltage for LCD system = Operating voltage at 25° C.

#### Mechanical Test

Vibration test	Endurance test applying the vibration during transportation and using	10~22Hz→1.5mmp-p 22~500Hz→1.5G Total 0.5hour	MIL-202E-201A JIS-C5025 JIS-C7022-A-10
Shock test	Constructional and mechanical endurance test applying the shock during transportation.	50G half sign wave 11 msede 3 times of each direction	MIL-202E-213B
Atmospheric pressure test	Endurance test applying the atmospheric pressure during transportation by air	115mbar 40hrs	MIL-202E-105C
Static electricity test	Endurance test applying the electric stress to the terminal	VS=800V,RS-1.5K Ω CS=100pF, 1 time	MIL-883B-3015.1

#### Failure Judgment criterion

Criterion Item	Test Item No.											Failure Judgment Criterion	
	1	2	3	4	5	6	7	8	9	10	11		
Basic specification													Out of the Basic specification
Electrical characteristic													Out of the DC and AC characteristic
Mechanical characteristic													Out of the Mechanical specification Color change: out of Limit Appearance Specification
Optical characteristic													Out of the Appearance Standard

### 3.2. QUALITY GUARANTEE

Acceptable Quality Level, Each lot should satisfy the quality level defined as follows.

-Inspection method: MIL-STD-105E LEVEL II Normal one time sampling

#### AQL

Partition	AQL	Description
A: Major	0.4%	Functional defective product
B: Minor	1.5%	Satisfy all functions as product but not satisfy cosmetic standard

### Definition of ‘LOT’

One lot means the delivery quality to customer at once time.

### Conditions of Cosmetic Inspection

#### . Environmental condition

The inspection should be performed at the 1metre height from the LCD module under 2 pieces of 40W white fluorescent lamps (Normal temperature 20~25°C and normal humidity 60±15%RH).

### Driving voltage

The Vo value which the most optimal contrast can be obtained near the specified Vo in the specification (Within of the typical value at 25°C.).

### 3.3. INSPECTION METHOD

The visual check should be performed vertically at more than 30cm distance from the LCD panel

Viewing direction for inspection is 45° from vertical against LCM.

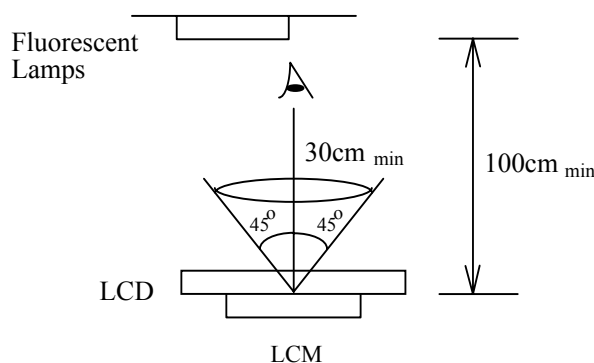

Definition of zone:

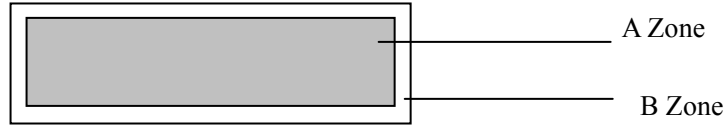

A Zone: Active display area (minimum viewing area).

B Zone: Non-active display area (outside viewing area).

### 3.4. INSPECTION STANDARD FOR SOLDER

#### Module Cosmetic Criteria

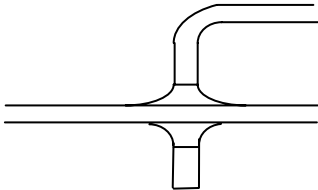
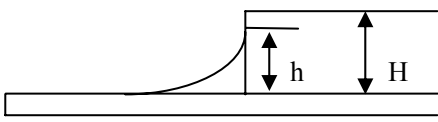
No.	Item	Judgment Criterion	Partition	
1	Difference in Spec.	None allowed	Major	
2	Pattern Peeling	No substrate pattern peeling and floating	Major	
3	Soldering defects	No soldering missing No soldering bridge No cold soldering	Major Major Minor	
4	Resist flaw on substrate	Invisible copper foil ( $\Phi 0.5\text{mm}$ or more) on substrate pattern	Minor	
5	Accretion of metallic Foreign matter	No soldering dust No accretion of metallic foreign matters (Not exceed $\Phi 0.2\text{mm}$ )	Minor Minor	
6	Stain	No stain to spoil cosmetic badly	Minor	
7	Plate discoloring	No plate fading, rusting and discoloring	Minor	
8	Plate discoloring	a. Soldering side of PCB Solder to form a 'Filet' all around the lead; Solder should not hide the lead form perfectly too much	Minor	
	1. Lead parts			
	2. Flat packages			
3. Chips	$(3/2) H \geq h \geq (1/2) H$		Minor	

**3.5. SCREEN COSMETIC CRITERIA(APPEARANCE)**

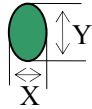
No.	Item	Criterion										
1	Short or open circuit	No allow										
	LC leakage											
	Flickering											
	No display											
	Wrong viewing direction											
	Wrong Back-light											
	Wrong or missing component											
2	Contrast defect (dim, ghost)	Refer to the approval sample										
	Background color deviation											
3	Point defect, Black spot, dust (including Polarizer) $\Phi=(X+Y)/2$	 <table border="1" data-bbox="860 824 1297 1077"> <thead> <tr> <th>Point Size</th> <th>Acceptable Qty.</th> </tr> </thead> <tbody> <tr> <td><math>\phi \leq 0.10</math></td> <td>Disregard</td> </tr> <tr> <td><math>0.10 &lt; \phi \leq 0.20</math></td> <td>6</td> </tr> <tr> <td><math>0.20 &lt; \phi \leq 0.3</math></td> <td>2</td> </tr> <tr> <td><math>\phi &gt; 0.30</math></td> <td>0</td> </tr> </tbody> </table>	Point Size	Acceptable Qty.	$\phi \leq 0.10$	Disregard	$0.10 < \phi \leq 0.20$	6	$0.20 < \phi \leq 0.3$	2	$\phi > 0.30$	0
Point Size	Acceptable Qty.											
$\phi \leq 0.10$	Disregard											
$0.10 < \phi \leq 0.20$	6											
$0.20 < \phi \leq 0.3$	2											
$\phi > 0.30$	0											

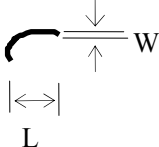
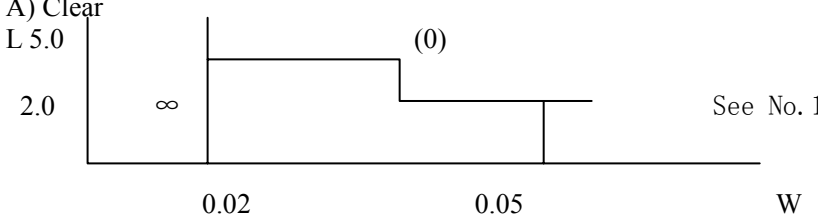
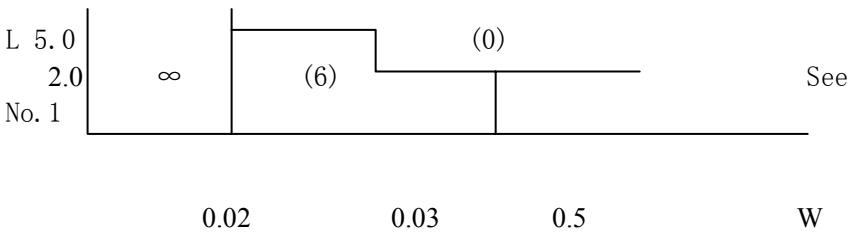
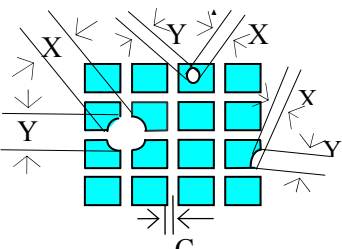
No.	Item	Criterion																			
4	<p>Line defect,</p> <p>Scratch: In accordance with spots and lines operating cosmetic criteria. When the light reflective on the panel surface, the scratches are not to be remarkable.</p>	 <table border="1" data-bbox="845 414 1396 672"> <thead> <tr> <th colspan="2">Line</th> <th rowspan="2">Acceptable Qty.</th> </tr> <tr> <th>L</th> <th>W</th> </tr> </thead> <tbody> <tr> <td>---</td> <td><math>0.015 \geq W</math></td> <td>Disregard</td> </tr> <tr> <td><math>3.0 \geq L</math></td> <td><math>0.03 \geq W</math></td> <td rowspan="2">2</td> </tr> <tr> <td><math>2.0 \geq L</math></td> <td><math>0.05 \geq W</math></td> </tr> <tr> <td><math>1.0 \geq L</math></td> <td><math>0.1 &gt; W</math></td> <td>1</td> </tr> <tr> <td>---</td> <td><math>0.05 &lt; W</math></td> <td>Applied as point defect</td> </tr> </tbody> </table> <p>Unit: mm</p> <p>A) Clear</p>  <p>B) Unclear</p>  <p>Note: ( ) –Acceptable Qty in active area L –Length (mm) W –Width (mm) <math>\infty</math> –Disregard</p>	Line		Acceptable Qty.	L	W	---	$0.015 \geq W$	Disregard	$3.0 \geq L$	$0.03 \geq W$	2	$2.0 \geq L$	$0.05 \geq W$	$1.0 \geq L$	$0.1 > W$	1	---	$0.05 < W$	Applied as point defect
Line		Acceptable Qty.																			
L	W																				
---	$0.015 \geq W$	Disregard																			
$3.0 \geq L$	$0.03 \geq W$	2																			
$2.0 \geq L$	$0.05 \geq W$																				
$1.0 \geq L$	$0.1 > W$	1																			
---	$0.05 < W$	Applied as point defect																			
5	Rainbow	Not more than two colors change across the viewing area																			
6	<p>Dot-matrix pattern</p> <p><math>\phi = (X+Y)/2</math></p>	<p>Pin hole:</p>  <table border="1" data-bbox="981 1680 1388 1836"> <thead> <tr> <th>Size</th> <th>Acceptable Qty.</th> </tr> </thead> <tbody> <tr> <td><math>\phi &lt; 0.1</math></td> <td>Disregard</td> </tr> <tr> <td><math>0.10 \leq \phi \leq 0.20</math></td> <td>1</td> </tr> <tr> <td><math>\phi &gt; 0.20</math></td> <td>0</td> </tr> </tbody> </table> <p>C: Shall not touch other dot(s).</p>	Size	Acceptable Qty.	$\phi < 0.1$	Disregard	$0.10 \leq \phi \leq 0.20$	1	$\phi > 0.20$	0											
Size	Acceptable Qty.																				
$\phi < 0.1$	Disregard																				
$0.10 \leq \phi \leq 0.20$	1																				
$\phi > 0.20$	0																				

<b>No.</b>	<b>Item</b>	<b>Criterion</b>
------------	-------------	------------------

7

Chip

Remark:

X: Length direction

Y: Short direction

Z: Thickness direction

t: Glass thickness

W: Terminal Width

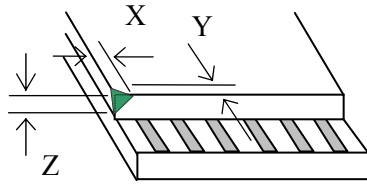

Acceptable criterion

X	Y	Z
$\leq 2$	0.5mm	$\leq t$

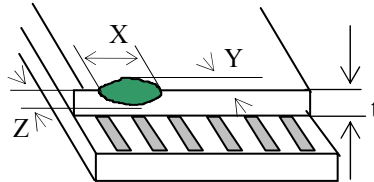

Acceptable criterion

X	Y	Z
$\leq 2$	0.5mm	$\leq t/2$

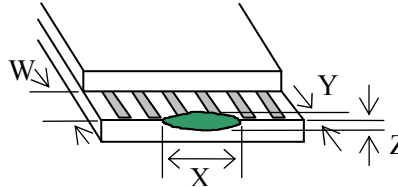

Acceptable criterion

X	Y	Z
Disregard	$\leq 0.2$	$\leq t$

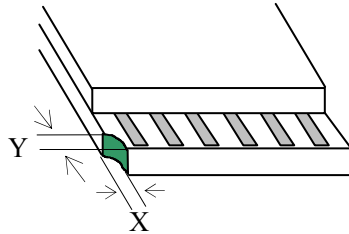

Acceptable criterion

X	Y	Z
$\leq 3$	$\leq 2$	$\leq t$
shall not reach to ITO		

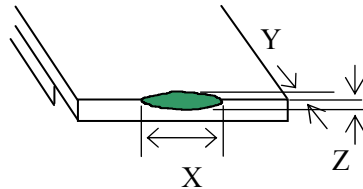

Acceptable criterion

X	Y	Z
$\leq 5$	$\leq 2$	$\leq t/3$

No.	Item	Criterion

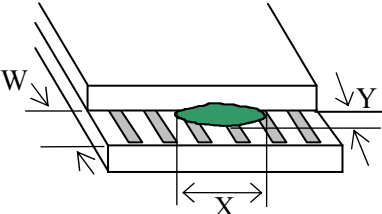
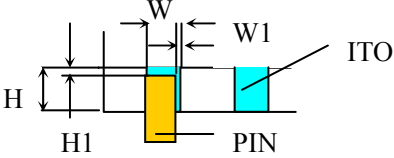
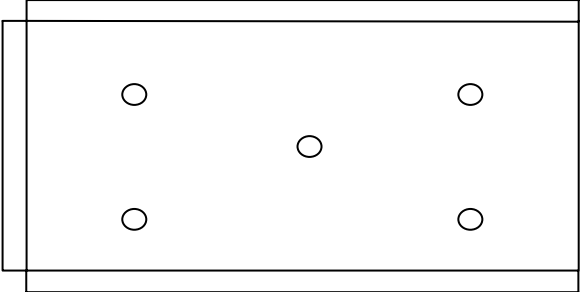
8	Total no. of acceptable Defect	<p>A. Zone</p> <p>Maximum 2 minor non-conformities per one unit. Defect distance: each point to be separated over 10mm</p> <p>B. Zone</p> <p>It is acceptable when it is no trouble for quality and assembly in customer's end product.</p>
9	Protruded W: Terminal Width	 <p>Acceptable criteria: <math>Y \leq 0.4</math></p>
10	PIN	<p>Position</p>  <div style="border: 1px solid black; padding: 5px; display: inline-block;"> <math>W1 \leq 1/3W</math>  <math>H1 \leq 1/3H</math> </div>
11	Uneven brightness (only back-lit type module)	<p>Uneven brightness must be <math>B_{MAX}/B_{MIN} \leq 2</math></p> <p>-BMAX : Max. value by measure in 5 points -BMIN : Min. value by measure in 5 points Divide active area into 4 vertically and horizontally. Measure 5 points shown in the following figure</p> 
12	Allowable density	Above defects should be separated more than 10mm each other.
13	Rubbing line	Not to be noticeable.
14	Dot size	To be 95% ~ 105% of the dot size (typ.) in drawing, Partial defects of each dot (ex. Pin-hole) should be treated as 'spot'.(see Screen Cosmetic Criteria (operating) No.)

No.	Item	Criterion
-----	------	-----------

15	Bubbles in polarizer	Size : d mm	Acceptable Qty in active area
		$d \leq 0.3$	Disregard
		$0.3 < d \leq 1.0$	3
		$1.0 < d \leq 1.5$	1
		$1.5 < d$	0
16	Allowable density	Above defects should be sea rated more than 30mm each other	
17	Coloration	Not to be noticeable coloration in the viewing area of the LCD panels. Backlit type should be judged with back-lit on state only.	
18	Contamination	Not to be noticeable.	

Note:

‘Clear’= the shade and size are not changed by  $V_0$ .

‘Unclear’= the shade and size are changed by  $V_0$ .

Size:  $d = (\text{long length} + \text{short length}) / 2$

The limit samples for each item have priority

Completed defects are defined item by item, but if the number of defects is defined in above table, the total number should not exceed 10.

In case of ‘concentration’, even the spots or the lines of ‘disregarded size should not allowed. Following three situations Should be treated as ‘concentration’.

-7 or over defects in circle of  $\Phi 2\text{mm}$

-10 or over defects in circle of  $\Phi 10\text{mm}$

-20 or over defects in circle of  $\Phi 20\text{mm}$

### 3.6. PRECAUTIONS FOR USING LCM MODULES

#### 1. Liquid Crystal Display Modules

LCD is composed of glass and polarizer. Pay attention to the following items when handing.

- (1) Please keep the temperature within specified range for use and storage. Polarization degradation, bubble generation or Polarizer peel-off may occur with high humidity.
- (2) Do not touch, push or rub the exposed polarizer with anything harder than an HB Pencil lead (Glass, tweezers, etc.).
- (3) N-hexane is recommended for cleaning the adhesives used to attach front/rear polarizers and reflectors made of organic, substances which will be damaged by chemicals such as acetone, toluene, ethanol and isopropyl alcohol.
- (4) When the display surface becomes dusty, wipe gently with absorbent cotton or other soft material like chamois soaked in petroleum Benin. Do not scrub hard to avoid damaging the display surface.
- (5) Wipe off saliva or water drops immediately, contact with water over a long period of time may cause deformation or color fading.
- (6) Avoid contacting oil and fats.
- (7) Condensation on the surface and contact with terminals due to cold will damage, stain or dirty the polarizers. After products are tested at low temperature the must be warmed up in a container before coming is contacting temperature air.
- (8) Do not put or attach anything on the display area to avoid leaving marks on.
- (9) Do not touch the display with bare hands. This will stain the display and degrade insulation between terminals (some cosmetics are determinate to the polarizer).
- (10)As glass is fragile. It tends to become or chipped during handling especially on the edges. Please avoid dropping

or jarring.

### 3.7. INSTALLING LCM MODULES

The hole in the printed circuit board is used to fit LCM as shown in the picture below. Attend to the following items when installing the LCM

(1) Cover the surface with a transparent protective plate to protect the polarizer and LC cell.

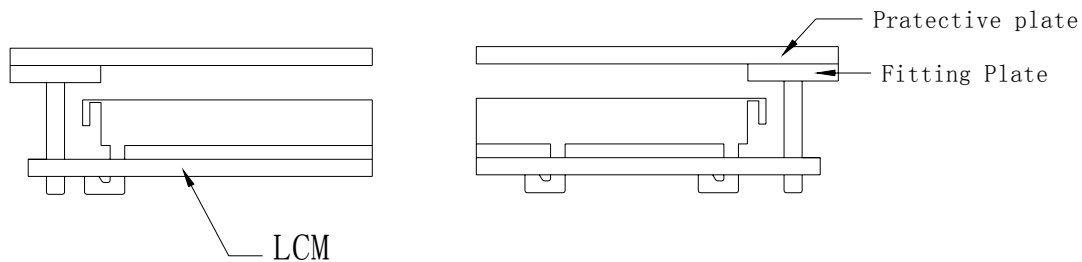

(2) When assembling the LCM into other equipment, the spacer to the bit between the LCM and the fitting plate should have enough height to avoid causing stress to the module surface, refer to the individual specifications for measurements. The measurement tolerance should be  $\pm 0.1\text{mm}$

### 3.8. PRECAUTION FOR HANDING LCM MODULE

Since LCM has been assembled and adjusted with a high degree of precision, avoid applying excessive shocks to the module or making any alterations or modifications to it.

- (1) Do not alter, modify or change shape of the tab on the metal frame
- (2) Do not make extra holes on the printed circuit board, modify its shape or change the positions of components to be attached.
- (3) Do not damage or modify the pattern writing on the printed circuit board.
- (4) Absolutely do not modify the zebra rubber strip (conductive rubber) or heat seal connector.
- (5) Except for soldering the interface, do not make any alterations or modifications with a soldering iron.
- (6) Do not drop, bend or twist LCM

### 3.9. ELECTRO-STATIC DISCHARGE CONTROL

Since this module uses a CMOS LSI, the same attention should be paid to electrostatic discharge as for an ordinary CMOS IC.

- (1) Make certain that you are grounded when handling LCM.
- (2) Before remove LCM from its packing case or incorporating it into a set, be sure the module and your body have the same electric potential.
- (3) When soldering the terminal of LCM, make certain the AC power source for the soldering iron does not leak.
- (4) When using an electric screwdriver to attach LCM, the screwdriver should be of ground potentiality to minimize as much as possible any transmission of electromagnetic waves produced sparks coming from the commutation of the motor.
- (5) As far as possible make the electric potential of your work clothes and that of the workbench the ground potential.
- (6) To reduce the generation of static electricity be careful that the air in the work is not too dried. A relative humidity of 50%-60% is recommended.

### **3.10. PRECAUTION FOR SOLDERING TO THE LCM**

- (1) Observe the following when soldering lead wire , connector cable and etc. to the LCM
  - Soldering iron temperature: 280°C±10°C
  - Soldering time: 3-4 seconds
  - Solder: eutectic solder.

If soldering flux is used, be sure to remove any remaining flux after finishing to soldering operation.(This does not apply in the case of non-halogen type of flux.) It is recommended that you protect the LCD surface with a cover during soldering to prevent any damage due to flux spatters.

- (2) When soldering the electro-luminescent panel and PC board, the panel and board should not be detached more than three times, This maximum number is determined by the temperature and time conditions mentioned above, though there may be some variance depending on the temperature of the soldering iron.
- (3) When remove the electro-luminescent panel from the PC board, be sure the solder has completely melted, the soldered pad on the PX board could be damaged.

### **3.11. PRECAUTIONS FOR OPERATION**

- (1) Viewing angle varies with the change of liquid crystal driving voltage (V<sub>0</sub>). Adjust V<sub>0</sub> to show the best contrast.
- (2) Driving the LCD in the voltage above the limit shortens its life.
- (3) Response time is greatly delayed at temperature below the operating temperature range. However, this does not mean the LCD cell be out of the order. It will recover when it returns to the specified temperature range.
- (4) If the display area is pushed hard during operation, the display will become abnormal, however, it will return to normal. If it is turned off and then back on. Used under the relative condition of 40°C, 50%RH.
- (5) When turning the power on input each signal after the positive/negative voltage becomes stable.

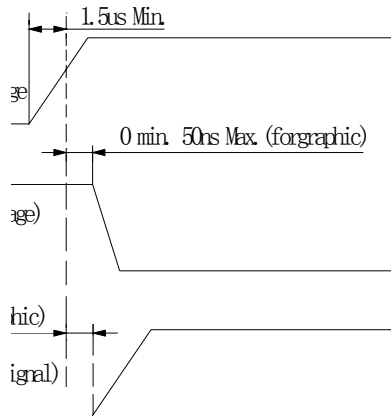

### 3.12. STORAGE

When storing LCD as spares for some years, the following precautions are necessary.

- (1) Store them in a sealed polyethylene bag. If properly sealed, there is no need for dessicant.
- (2) Store them in a dark place. Do not expose to sunlight or fluorescent light, keep the temperature between 0°C and 35°C
- (3) The polarizer surface should not come in contact with any other object.(we advise you to store them in the container in which they were shipped.)
- (4) Environmental conditions:
  - Don not leave them for more than 168hrs. at 60°C
  - Should not be left for more than 48hrs. at -20°C.

### 3.13. SAFETY

- (1) It is recommended to crush damaged or unnecessary LCD into pieces and wash them off with solvents such as acetone and ethanol, which should later be burned.
- (2)If any liquid leaks out of a damaged glass cell and comes in contact with the hands, wash off thoroughly with soap and water.

### 3.14. LIMITED WARRANTY

Unless agreed between TINSHARP and customer, TINSHARP will replace or repair any of its LCD modules which are found to be functionally defective when inspected in accordance with TINSHARP LCD acceptance standards (copies available upon request) for a period of one year from date of shipments. Cosmetic/visual defects must be returned to TINSHARP within 90 days of shipment. Confirmation of such date shall be based on freight documents. The warranty liability of TINSHARP limited to repair and/ or replacement on the terms set forth above. TINSHARP will not be responsible for any subsequent or consequential events.

### 3.15. RETURN LCM UNDER WARRANTY

No warranty can be granted if the precautions stated above have been disregarded. The typical examples of violations are:

- Broken LCD glass.
- PCB eyelet's damaged or modified.
- PCB conductors damaged.
- Circuit modified in any way, including addition of components.
- PCB tampered with by grinding, engraving or painting varnish.
- Soldering to or modifying the bezel in lay manner.

Module repairs will be invoiced to the customer upon mutual agreement. Modules must be returned with sufficient description of the failures or defects. Any connectors or cable installed by the customer must be removed completely without damaging the PCB eyelets, conductors and terminals.

## 4. DATE CODE RULES

### 4-1. DATE CODE FOR SAMPLE

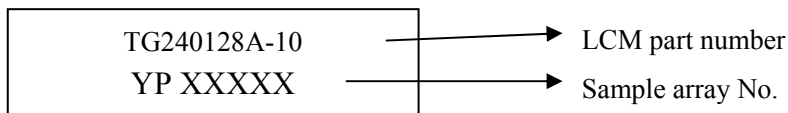

YP: meaning sample

### 4-2. DATE CODE FOR PRODUCTION

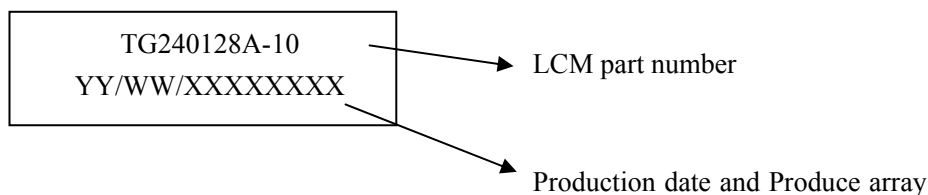

A. TG240128A-10 represents LCM part number

C. YY/WW represents Year, Week

YY—Year      WW—Week

XXXXXXXX—Produce array No.

\*\*\*END\*\*\*